

# LOWER DON RIVER

DUE DILIGENCE AND VALIDATION REPORT - 2016/03/21



Landscape Architect

**Michael Van Valkenburgh Associates, Inc.**

Civil Engineer

**MMM Group, Ltd.**

Geotechnical / Environmental Engineer

**Golder Associates, Ltd.**

Hydrology / Geomorphology

**LimnoTech, Inc.**

Ecology

**Inter-Fluve, Inc.**



# CONTENTS

<b>1. EXECUTIVE SUMMARY</b>	<b>11</b>
1.1 Background	11
1.2 Design Team	11
1.3 Vision	12
1.4 Report Structure and Use	12
<b>2. INFRASTRUCTURE</b>	<b>13</b>
2.1 Transportation	13
2.1.1 Road Network	13
2.1.2 Bridges	16
2.1.2.1 Cherry Street Bridge	16
2.1.2.2 South Cherry Street Bridge (Polson Slip)	16
2.1.2.3 Commissioners Street Bridge	20
2.1.2.4 Basin Street Bridge	24
2.1.2.5 Munition Street Bridge	28
2.1.2.6 Trinity Street Footbridge	29
2.1.2.7 Keating Channel Footbridge	29
2.1.2.8 Lake Shore Blvd. Crossing	29
2.1.3 Transit Networks	29
2.2 Water / Waste Water	29
2.2.1 Water Distribution Network	29
2.2.1.1 Fire Protection	30
2.2.2 Sanitary Servicing	30
2.2.2.1 Commissioner's Street Pumping Station	31
2.2.3 Storm Servicing	32
2.2.3.1 Minor Stormwater System	32
2.2.3.2 Major Stormwater System	34
2.3 Stormwater Management	34
2.3.1 Keating Channel Recirculation	36

2.4	Utilities	36
2.4.1	Existing Utilities	36
2.4.2	Decommissioning Services in Coordination with Phased Earthwork	37
2.4.3	Proposed Utilities	37
<b>3.</b>	<b>FLOOD PROTECTION</b>	<b>39</b>
3.1	Geomorphology and Slope Armouring	39
3.1.1	Overall River Valley Stability	39
3.1.2	River Geomorphology	39
3.1.3	Base Flow River Channel Slope Stability and Design Recommendations	40
3.1.4	Ice Management	45
3.2	Flow Control Weir	45
3.2.1	Adjustable Upstream Weir	47
3.2.2	Sidelflow Weir	49
3.2.3	System Adaptability	49
3.3	Spillway	50
3.4	Wetland Control Structures	50
3.5	Sediment and Debris Management	51
3.6	Don Roadway Valley Wall Feature	51
3.7	Eastern Avenue Flood Protection	51
3.8	First Gulf Flood Protection Landform	51
<b>4.</b>	<b>PUBLIC REALM AND PARKLAND FOR RECREATIONAL USE</b>	<b>53</b>
4.1	Program and Circulation	53
4.1.1	Streetscape	58
4.2	Topography	58
4.3	Planting	58
4.3.1	Park Planting Strategy	59
4.3.2	Floodplain Planting Strategy	59
4.3.2.1	Aquatic Habitat and Site Ecology	59
4.3.3	Planting Soils	60
4.4	Maintenance	62

<b>5. EARTHWORK</b>	<b>65</b>
5.1 Preliminary Assessment of Environmental Conditions	65
5.1.1 Existing Conditions	65
5.1.2 General Principles	65
5.1.3 Anticipated Requirements and Parallels to Other Designated Waterfront Area Developments	66
5.1.3.1 Barriers to Existing Site Soils	66
5.1.3.2 Barriers to Limit Migration of Contaminants into River Channel	67
5.1.3.3 Barriers to Limit Migration of Vapours in a Closed Area	67
5.2 Preliminary Geotechnical Assessment	68
5.2.1 Subsurface Conditions – Geotechnical Setting	71
5.2.2 Settlement Due to Grade Raises	72
5.2.3 Settlement Mitigation Measures	73
5.2.3.1 Preloading	73
5.2.3.2 Surcharging	73
5.2.3.3 Wick Drains (in Conjunction with Surcharging)	74
5.2.3.4 Sub-Excavation and Replacement	74
5.2.3.5 Lightweight Fill	74
5.2.3.6 Ground Improvement	75
5.2.3.7 Instrumentation and Monitoring	75
5.2.4 Valley Wall Features	75
5.2.5 Essroc Quay Lakefill	76
5.2.5.1 Confinement Structure – Berm	76
5.2.5.2 Confinement Structure – Structural Wall	77
5.2.5.3 In-Water Fill	77
5.2.5.4 Above-Water Fill	78
5.2.6 Structure Foundations	78
5.2.7 Keating Channel and Existing and New Dock Walls	79
5.2.8 Subsurface Structures and Utilities	82
5.2.9 New River Channel and Spillway	84
5.2.9.1 Excavation/Dredging	84
5.2.9.2 Geotechnical Aspects of Environmental Barrier	85
5.2.9.3 Surficial Protection	85
<b>6. CONCLUSION</b>	<b>89</b>

# TABLE OF FIGURES

<b>FIGURE 2-1:</b> <i>Detail Plan - Bike Lane Transition at Cherry Street and Lake Shore Boulevard</i>	13
<b>FIGURE 2-2:</b> <i>Cherry Street Bike Lane Alignment Diagram</i>	14
<b>FIGURE 2-3:</b> <i>Commissioners Street/Don Roadway Alignment</i>	15
<b>FIGURE 2-4:</b> <i>South Cherry Street (Polson Slip) Bridge Redesign</i>	18
<b>FIGURE 2-5:</b> <i>Commissioners Street Bridge Redesign</i>	22
<b>FIGURE 2-6:</b> <i>Basin Street Bridge Redesign</i>	26
<b>FIGURE 3-1:</b> <i>Geomorphology and Slope Armouring Diagram</i>	40
<b>FIGURE 3-2:</b> <i>Example of bioengineered bank</i>	41
<b>FIGURE 3-3:</b> <i>Example of exposed armouring</i>	41
<b>FIGURE 3-4:</b> <i>Armouring integrated with circulation</i>	41
<b>FIGURE 3-5:</b> <i>Examples of woody toe armouring</i>	42
<b>FIGURE 3-6:</b> <i>Examples of gravel bank</i>	43
<b>FIGURE 3-7:</b> <i>EFDC model representation of weir system</i>	46
<b>FIGURE 3-8:</b> <i>Example of inflatable adjustable weir</i>	47
<b>FIGURE 3-9:</b> <i>Proposed inflatable weir profile</i>	48
<b>FIGURE 4-1:</b> <i>Park Program Concept Diagram</i>	53
<b>FIGURE 4-2:</b> <i>Full Vision Floodplain and Park Program Plan</i>	54
<b>FIGURE 4-3:</b> <i>Scale and Capacity Program Study</i>	55
<b>FIGURE 4-4:</b> <i>Valley and Park Circulation</i>	56
<b>FIGURE 4-5:</b> <i>Example of boardwalk crossing at wetland and river channel</i>	57
<b>FIGURE 4-6:</b> <i>Example of short span boardwalk crossing at wetlands</i>	57
<b>FIGURE 4-7:</b> <i>Example of armoured boat launch</i>	58
<b>FIGURE 4-8:</b> <i>Example of large wood stabilization</i>	60
<b>FIGURE 4-9:</b> <i>Plan Diagram of Planting Soils</i>	61

# INDEX OF TABLES

<b>TABLE 5.2-1:</b> <i>Summary of Preliminary Geotechnical Considerations and Requirements by Project Element</i>	69
<b>TABLE 5.2-2:</b> <i>Deep Foundations for Proposed Bridges - Preliminary Depth to Bedrock</i>	79
<b>TABLE 5.2-3:</b> <i>Summary of Feasible Channel Wall Types</i>	81
<b>TABLE 5.2-4:</b> <i>Subsurface Structures and Utilities - Preliminary Geotechnical Considerations</i>	82

# ABBREVIATIONS

AHT	Aquatic Habitat Toronto
BFF	Bioflocculation facility
CBRA	Community Based Risk Assessment
DMNP	Don Mouth Naturalization and Portlands
EA	Environmental Assessment
EAMP	Environmental Assessment Master Plan
EAR	Environmental Assessment Report
ESR	Environmental Study Report
FPL	Flood Protection Landform
GCB	Grade Control Barrier
LDL	Lower Don Lands
LRT	Light Rapd Transit
MOECC	Ministry of Environment and Climate Change
MVVA	Michael Van Valkenburgh Associates, Inc.
RSC	
SWM	Stormwater Management
TRCA	Toronto and Region Conservation Authority
TTC	Toronto Transit Commission
VWF	Valley Wall Feature
WSE	Water Surface Elevation



# APPENDICES

Appendix A: Flood Modelling Result Maps	91
A-1 Water Surface Elevation	
A-2 Velocity	
A-3 Shear Stress	
A-4 Critical Sediment Size at Initial Motion	
Appendix B: Typical Conceptual Design Sections and Design Solution Fact Sheets	108
Appendix C: Preliminary Settlement Estimates in Grade Raise Areas	115



# 1 EXECUTIVE SUMMARY

This Due Diligence Report for the Lower Don River/Port Lands Flood Protection Project provides further design development and refinement of information for the Lower Don River design, based on data and assumptions from the regulatory documents, and informed by further site analysis carried out by others under contract with Waterfront Toronto. The ultimate vision for this project is the reinvention of this neighbourhood. This will start with the naturalization of the mouth of the Don River along with flood protection measures that are urgently needed. The critical work that will be advanced as part of the Lower Don River/Port Lands Flood Protection Project will lay the groundwork and infrastructure for the urban redevelopment and neighbourhood-building efforts to follow.

## 1.1 BACKGROUND

In the larger Lower Don Lands/Port Lands Project, the engine of transformative urbanism is a dramatic repositioning of natural systems, landscape systems, transportation systems, and architectural environments. The plan creates a new mouth for the Don River, thus enabling Toronto to reclaim the functional and experiential benefits of river ecology. The Lower Don Lands Plan, anchored by essential provincial and municipal approvals, couples the pragmatics of flood control and river hydrology with the reconstruction of the river's mouth as a symbolic and literal center around which a new sustainable neighbourhood can emerge.

The 113-hectare former port facility is currently an industrial artifact, devoid of natural features, public infrastructure, and neighbourhood amenities. Regional hydrology has been highly altered through urban development and the river has occasional surges that result in damaging floods. Although the new river mouth is not a restoration of the site's original ecology, hydrologic modeling demonstrates that it will be a viable method for protecting against flooding. Beyond this, the river mouth will also introduce new ecological and experiential benefits.

The previous regulatory documents that this report references and builds upon are the 2010 Lower Don Lands Infrastructure Master Plan and Keating Channel Precinct Environmental Study Report, (2010 LDL ESR), and Appendices, the 2014 Don Mouth Naturalization and Port Lands Flood Protection Project Environmental Assessment, (2014 DMNP EAR), and the 2014 Lower Don Lands Environmental Assessment Master Plan Addendum and Environmental Study Report, (2014 LDL EAMP).

## 1.2 DESIGN TEAM

Although most major aspects of work have remained in compliance with the previous regulatory documents, some modifications have been proposed as a result of the integration of new site data with the project design. As the project evolves, every effort is made to maintain design solutions approved by regulatory documents. This Due Diligence Report will augment these documents with the most

recent information, providing further direction for subsequent design and documentation phases of work. Any modifications to the proposed design are clearly highlighted and documented in the following report. In addition to augmenting technical information, the report will provide further detailed description of the public realm vision for the river valley, including the landscape within the floodplain as well as parkland above the regulatory event extents.

This report is an up to the minute accounting of high level decisions, informed by site analysis and approved regulatory documents. As a supplement to the years of planning that have preceded it, it is intended to be used in service of the development of a more refined cost estimate, thus helping smooth the way for the Flood Protection Project phase to get underway.

### **1.3 VISION**

Michael Van Valkenburgh Associates, Inc. (MVVA), is the lead planner and landscape architect for the project, working with a team of consultants, including MMM, Ltd., (Civil Engineer), LimnoTech, Inc., (Hydrology/Geomorphology), Inter-Fluve, Inc., (Ecology), and Golder Associates, Ltd. (Geotechnical/Environmental Engineer), to advance the design concept for the floodplain, flood protection, parkland, and provision of services for future city building. This design development is outlined within the content of this report and accompanying set of drawings. This development offers refinement of areas of high uncertainty in the previous cost estimate, such as landscape components and treatment of the floodplain, and quality and quantity of program within the floodplain and parkland.

### **1.4 REPORT STRUCTURE AND USE**

The following report reflects the structure of the previous regulatory documents, including, outlining approaches towards infrastructure and flood protection in chapters 2 and 3. Further development on ideas of construction and materials in the floodplain for the desired quality of public space, program, and ecological habitat are reflected in chapter 4. Chapter 5 provides preliminary environmental and geotechnical assessment of the site based on conceptual design proposals and site information.

# 2 INFRASTRUCTURE

The following sections describe any significant changes to the Transportation, Water and Waste Water, Stormwater Management, and Utilities planning alternatives within the Lower Don Lands study area since the 2010 LDL ESR, 2014 LDL EAMP Addendum & ESR, and 2014 DMNP EAR were released.

Additional information on preliminary geotechnical considerations associated with the proposed infrastructure can be found in Chapter 5 of this report.

## 2.1 TRANSPORTATION

### 2.1.1 ROAD NETWORK

All roads construction and sidewalks will need to extend 1.5m deep, made up of typical road construction profile and clean fill below, to provide required depth of clean fill above existing soils.

Refer to Section 4.1.1 below for description of the quality of streetscape and public realm associated with the road network.

Figure 6.15 within the 2014 LDL EAMP Addendum & ESR documents latest changes to Preferred Roads and Bridges.

The approved cross section of New Cherry Street is described in section 6.1.4 of the 2014 LDL EAMP Addendum & ESR, and illustrated in Figure 6-2. The ROW for New Cherry Street has since been revised to be 40m wide total, per design study by the Villiers Island Precinct design team.

The alignment of new bike lanes along Cherry Street has been studied as part of the Due Diligence phase of work. Based on these studies, the preferred approach was

determined to provide a dedicated bike lane along the east side of Cherry Street, south of Lake Shore Boulevard. **Figure 2-1** illustrates in plan the proposed transition from on-road bike lanes north of Lake Shore Boulevard to the dedicated bike lane east of the new Cherry Street alignment. This proposed layout integrates the existing east-west Lower Don

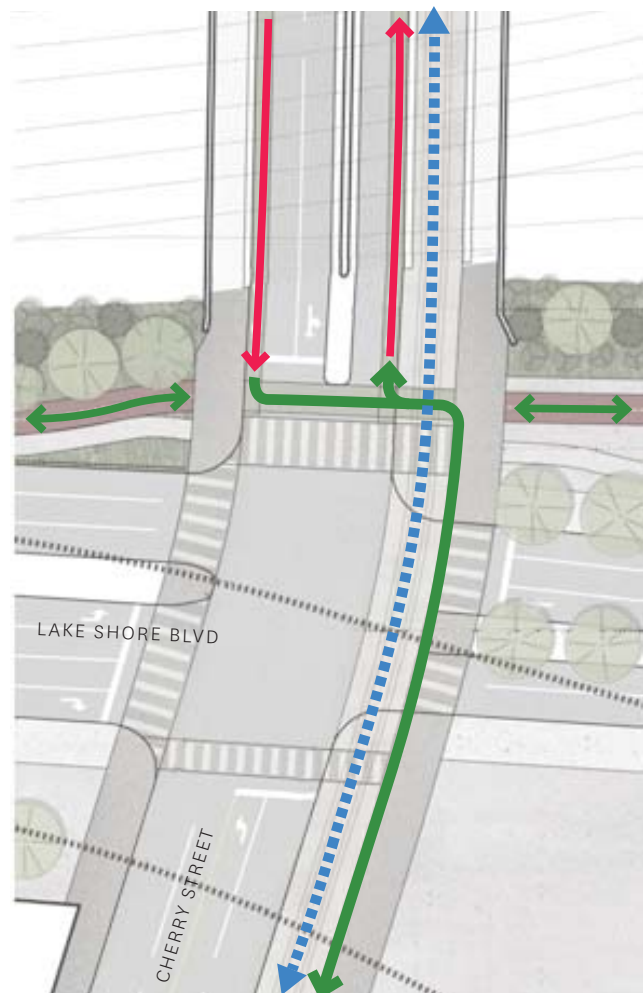

**FIGURE 2-1:** Detail Plan - Bike Lane Transition at Cherry Street and Lake Shore Boulevard

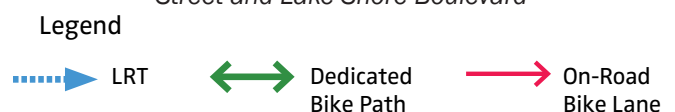



**FIGURE 2-2:** Cherry Street Bike Lane Alignment Diagram

**Legend**

LRT

Dedicated Bike Path

On-Road Bike Lane

Regulatory Flood Line

River Trail dedicated bike path, providing direct connections, and a smooth transition for cyclists to the Cherry Street dedicated bike lane, minimizing conflicts with crossing at Lake Shore Boulevard. **Figure 2-2** illustrates the bike lane alignment relative to other modes of travel. Several advantages to this layout were identified, including the following:

- The east alignment is consistent with the Port Lands TSMP configuration continuing south from the Ship Channel Bridge;

- This alignment provides a more desirable crossing of vehicular and LRT lanes at Commissioners Street than other studied alternatives;
- More direct connections are provided to the multi-use trail within the river parks.

A few disadvantages were also noted:

- The dedicated bike path would be part of Phase 2 of Cherry Street South bridge construction, if bridges are constructed with phased approach;

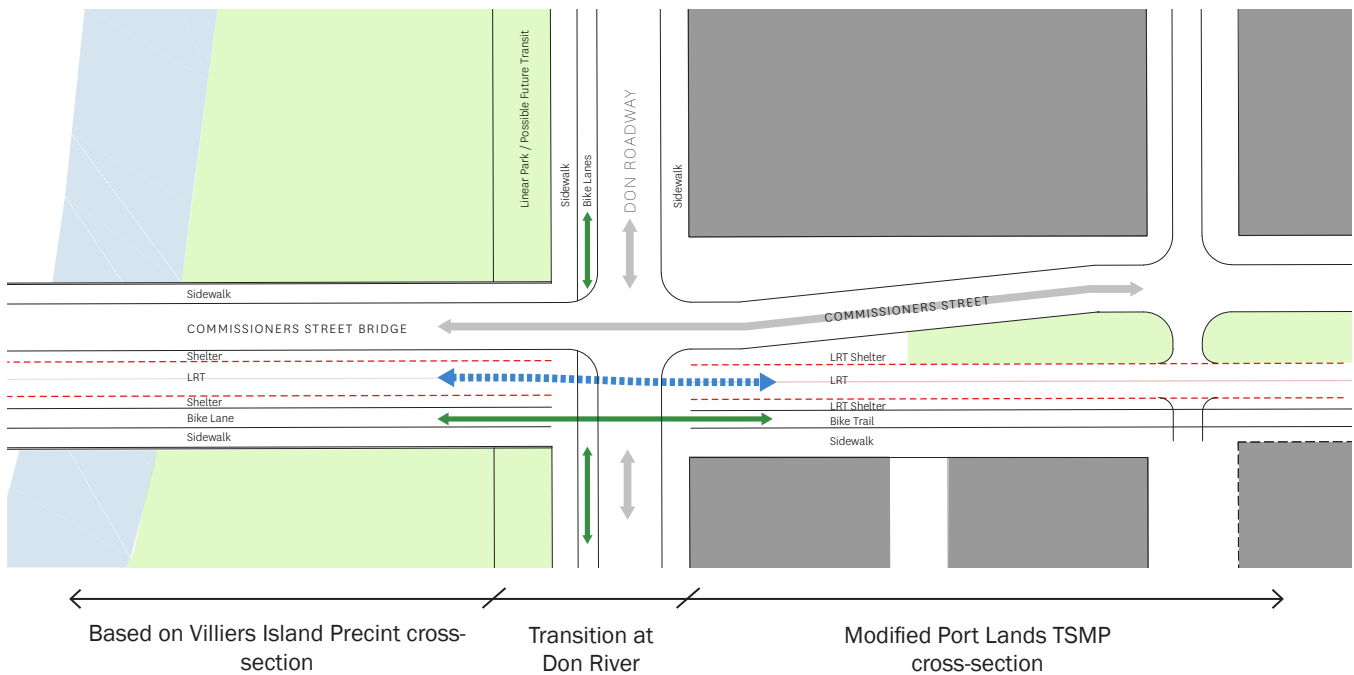

**FIGURE 2-3:** Commissioners Street/Don Roadway Alignment



**Legend**

- Vehicular Travel
- LRT Travel
- Bike Travel

- There will be an increased conflict with bikes and side street traffic at Villiers Island and Polson Quay than other studied alternatives;
- Multiple crossings will be needed at the LRT turn-around at Polson Quay;
- A transition to the Queens Quay dedicated bike path will require a crossing at Cherry Street.

The coordination of all traffic routes will be further studied and coordinated in future phases of work.

The approved cross section of Commissioners Street is described in section 6.1.6 of the 2014 LDL EAMP Addendum & ESR, and illustrated in Figure 6.7. The ROW for Commissioners Street has since been revised to be 40m wide total, per design study by the Villiers Island Precinct design team.

The ROW and cross-section of Commissioners Street varies between the Villiers Island Precinct

and the Port Lands TSMP. The transition of the road alignment and lane configuration has been studied in the Due Diligence phase of work. The Villiers Island Precinct alignment is proposed to continue across the Commissioners Street bridge, and the transition to the Port Lands TSMP alignment will happen east of the Don Roadway, as illustrated in **Figure 2-3**. This transition will be further studied and coordinated in future phases of work.

The approved cross section for Don Roadway is described in section 6.1.9 of the 2014 LDL EAMP Addendum & ESR, and illustrated in Figure 6-12. The Don Roadway profile was modified by moving the linear park/possible future transit to the west side of the bike lane and sidewalk.

The approved cross section for Villiers Street is described in section 6.1.10 of the 2014 LDL EAMP Addendum & ESR, and illustrated in figure 6-14.

## 2.1.2 BRIDGES

Figure 6.15 within the 2014 LDL EAMP Addendum & ESR documents latest changes to Preferred Roads and Bridges.

Figure 6-23 within the 2014 DMNP EAR exhibits Proposed Bridge Crossings.

No significant changes to Vehicle and Rail Crossings have occurred since 2014.

All bridges considered during the Due Diligence phase have been designed to meet the following design criteria:

- Bridges to meet the requirements of Canadian Highway Bridge Design Code (CHBDC) most recent version and the Toronto Transit Commission (TTC) Design Manual;
- Streetcar load to be LFLRV (66500 kg maximum vehicle weight; 11,800 kg axle load) or approved equivalent;
- Durability strategy to be stainless steel in barriers, sidewalks and top layer of reinforcing in the deck; waterproof under asphalt and TTC infill concrete; use integral abutment design with no expansion joints;
- Clearance under the bridges to be minimum of 2,500 mm over pathways or 500 mm freeboard over the regulatory water elevation from the regulatory flood event, as may be required by the Conservation Authority;
- Lighting to be provided on bridges to same level as the approaches;
- Drainage to be provided to meet requirement for minimum spread into driving lane in design storm;
- For concrete girders:
  1. The maximum tensile stresses in service shall not exceed 0.5 fcr
  2. For all prestressed concrete elements

that will receive additional permanent compressive stress at the location under investigation, the limiting concrete tensile stress at transfer shall be 0.6 fcr;

3. For all prestressed concrete elements that will not receive additional permanent compressive stress at the location under investigation, the limiting concrete tensile strength at transfer shall be 0.5 fcr;

4. The cracking strength of the concrete fcr or fcr shall be calculated as  $(0.4 fcr)^{0.5}$  or  $0.4 (fcr)^{0.5}$  for stresses at transfer and in service as specified in CHBDC.

- Barriers shall be TL-2, with pedestrian rail, for a total height of 1015 mm or as required by the CHBDC (most recent version).

All bridge designs will continue to be tested through flood modelling in the following design phases of work in order to ensure the structure does not impede flood conveyance in the regulatory event.

### 2.1.2.1 Cherry Street Bridge

Figure 15-12 within the 2010 LDL ESR exhibits Preferred Cherry Street Bridge Concept Design.

Figure 6.5 within the 2014 LDL EAMP Addendum & ESR exhibits Cherry Street Bridge Redesign.

Figure 3-7 within the 2014 LDL EAMP Addendum & ESR presents Waterfront Toronto's Proposed Cherry Street Transit Configuration Crossing Keating Channel.

No significant changes to Cherry Street Bridge have occurred since 2014.

### 2.1.2.2 South Cherry Street Bridge (Polson Slip)

**Figure 2-4** shows one (1) alternative for the South Cherry Street Bridge. The proposed crossing consists of two (2) superstructures with reinforced concrete slab approach spans



and single span steel through arch. The steel arch span has been preliminarily set at a space of 80 m, although that length of span conflicts with the existing curvature of the road right-of-way. In **Figure 2-4** the road alignment has been revised to suit the main arch span.

If this alignment adjustment was not possible due to other constraints, then a reduced 40 m span through arch is feasible, combined with two (2) 20 m span cast-in-place concrete approach spans at both the north and south end of the arch (total bridge length 120 m).

A third alternative would be to have a bridge consisting of six (6) 20 m cast-in-place concrete spans. This would be similar to the proposed Basin Street Bridge for both span arrangement and structure type. Such a structure can match the geometric constraints of the proposed curved right-of-way, is less costly and we believe would have reduced life cycle costs compared to any combination with either a 40 m or 80 m arch span. In addition, the superstructure of a cast-in-place bridge, with an estimated deck thickness of approximately 1,050 mm is one of the thinner structure types possible.

The currently proposed structure in **Figure 2-4** would have expansion joints at both ends of the arch span. The abutments could be made integral with the end spans, thereby eliminating the need for expansion joints at the abutments.

The pier caps could be made integral with the approach span slabs providing a smooth soffit, individual columns or other “open type” piers could support both the end of the arch and the approach span.

As mentioned above, the superstructure has been shown divided into two (2) parts. The transit modes have been separated onto the east bridge. This would facilitate staged construction if desired.

The proposed cross section of the crossing will consist of the following:

West	
TL-2 Barrier with Railing	300 mm
Sidewalk	3,400 mm
Southbound Lane	3,500 mm
Turning Lane	3,000 mm
Northbound Lane	3,500 mm
Buffer	1,200 mm
TL-2 Barrier with Railing	300 mm
Superstructure Separation (Between Arch's)	3,660 mm*
TL-2 Barrier with Railing	300 mm
Buffer	2,500 mm
Southbound Transit Lane	3,500 mm
Northbound Transit Lane	3,500 mm
Buffer	1,200 mm
Bike Lane	3,600 mm
Sidewalk	4,000 mm
TL-2 Barrier with Railing	300 mm

\*Will vary for arc and approach span.

The total anticipated width is approximately 40,000 mm.

The cross falls for the traffic and bicycle lanes would be 2% east and west, with deck drainage provided along both curbs in the non-transit superstructure. The transit lanes would be constructed flat with slope for drainage provided by longitudinal grade (TTC would need to confirm method of attaching rails to bridge and drainage).

The proposed durability strategy for this bridge would be as follows:

- Use stainless steel in the top mat of deck reinforcing; similar corrosion resistant reinforcing material would be used in the sidewalks and barriers;

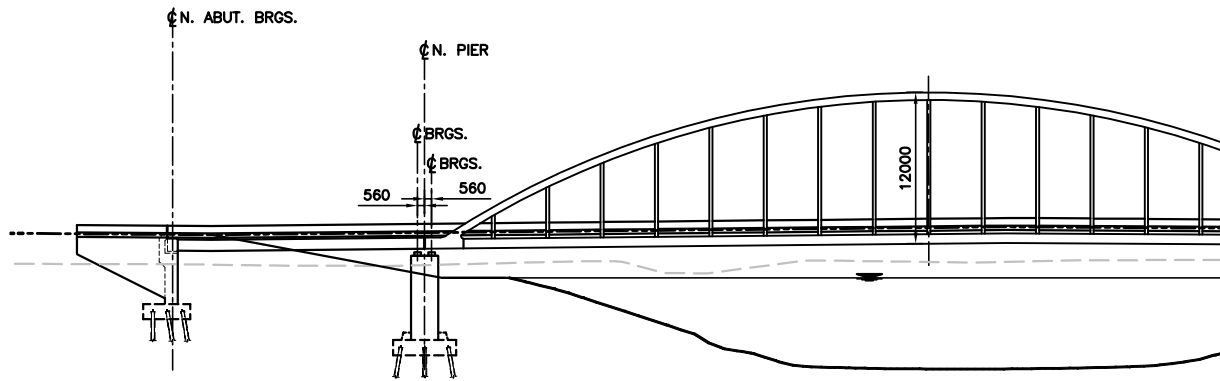

**ELEVATION**  
1:300

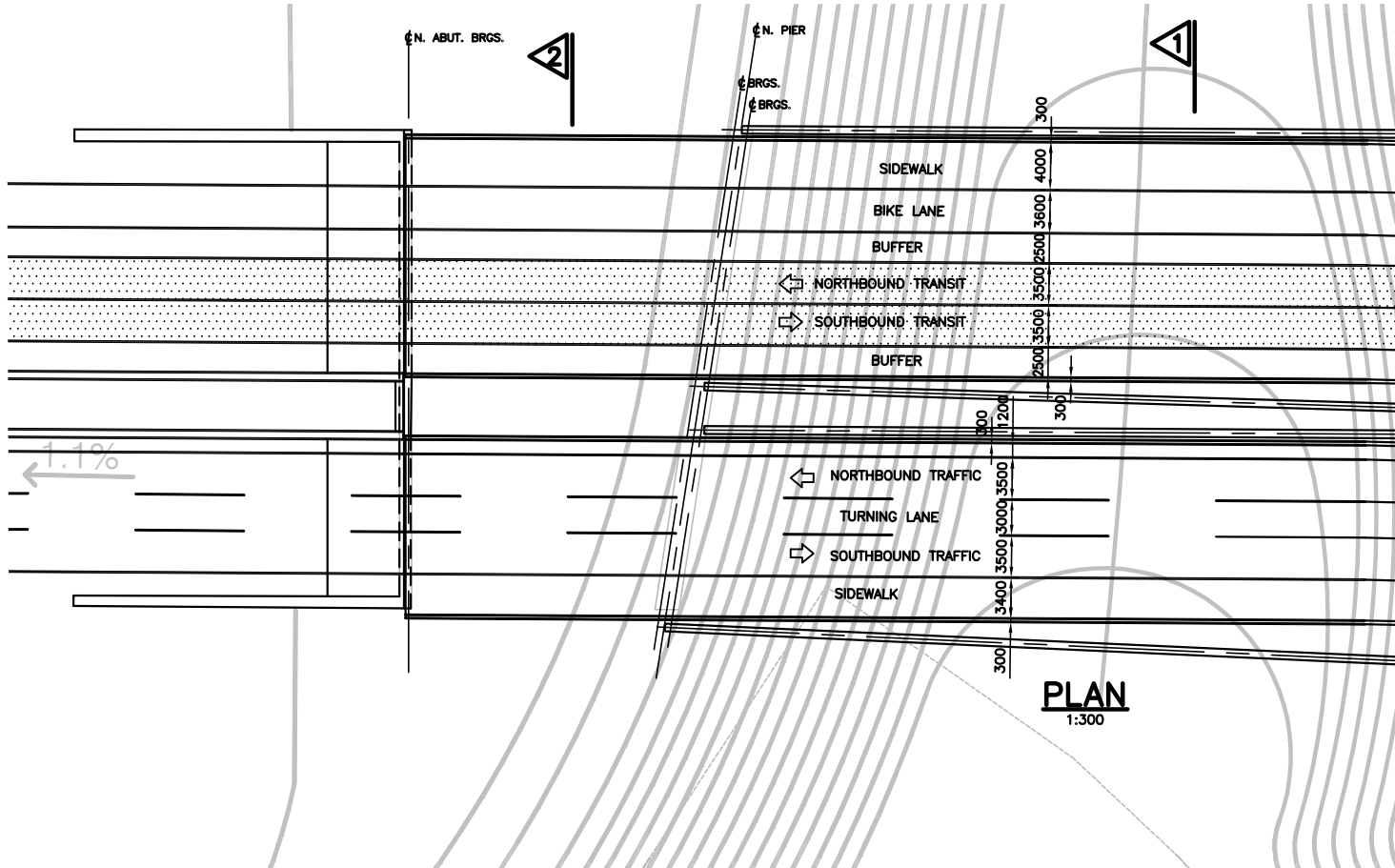

**PLAN**  
1:300

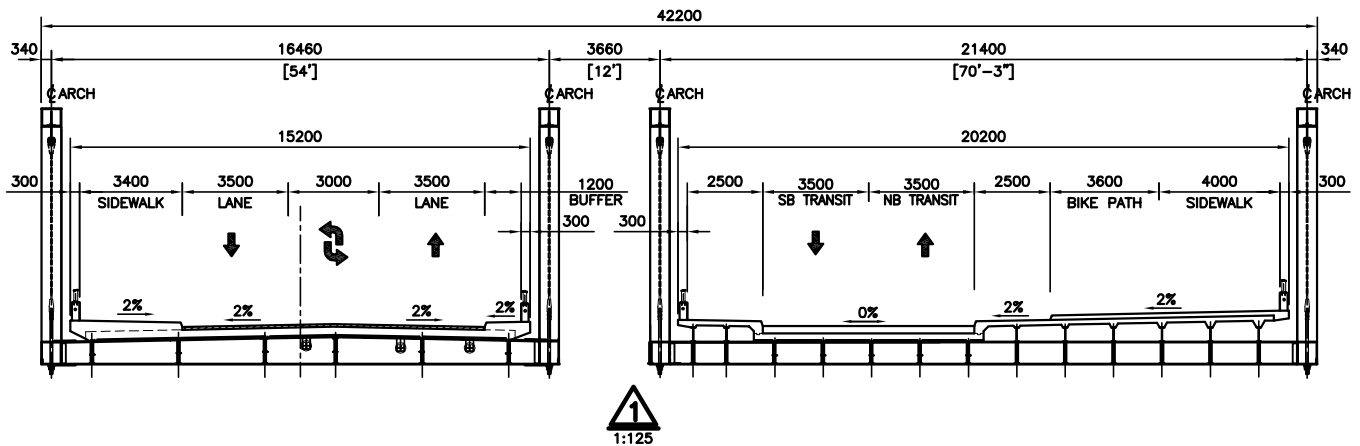

**1**  
1:125

**FIGURE 2-4: South Cherry Street (Polson Slip) Bridge Redesign**

LOWER DON LANDS  
SOUTH CHERRY STREET BRIDGE  
ALTERNATIVE 1

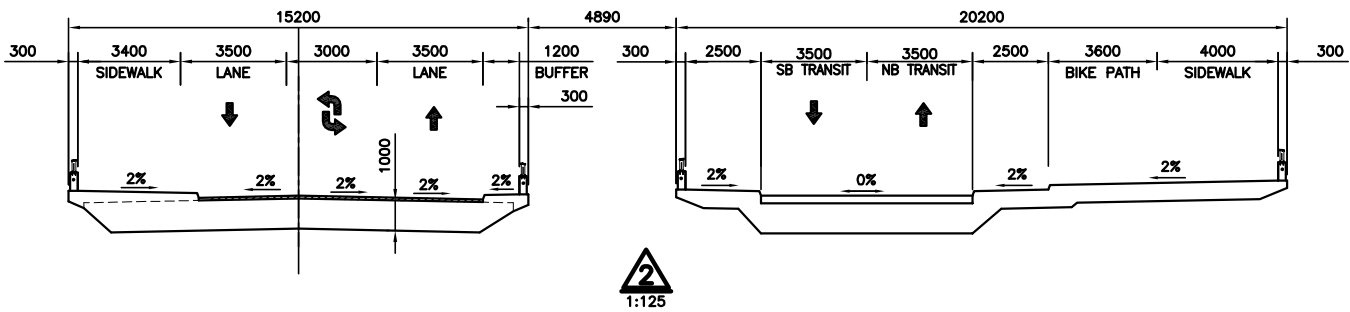
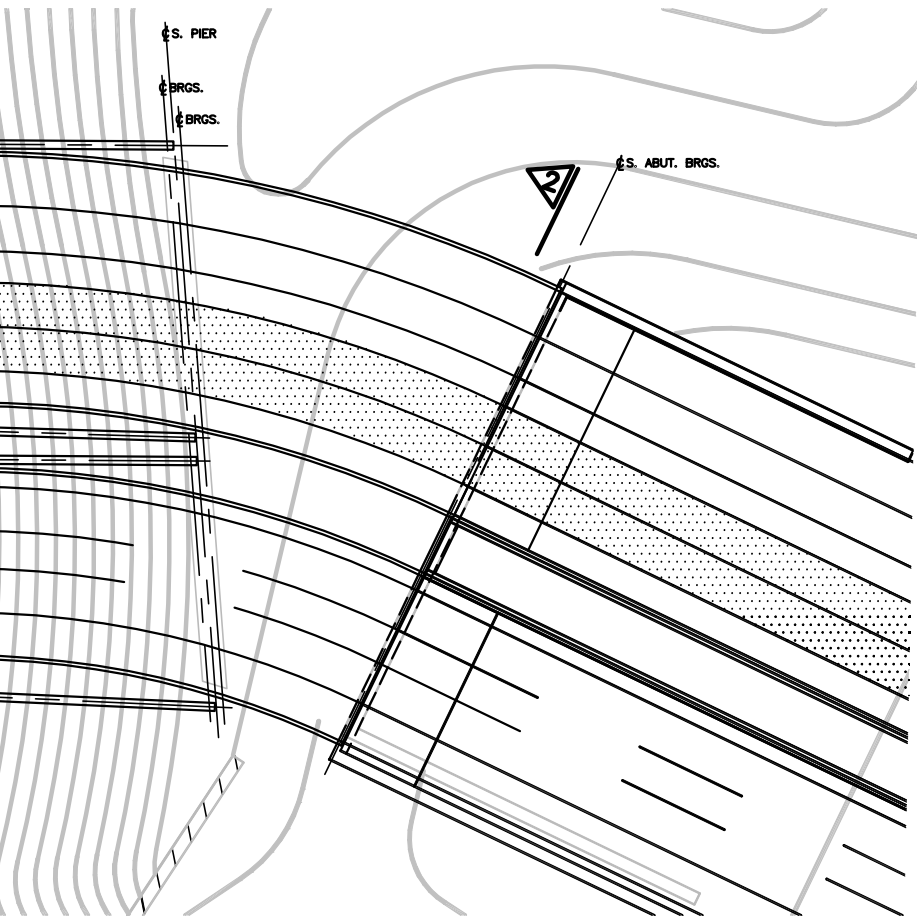
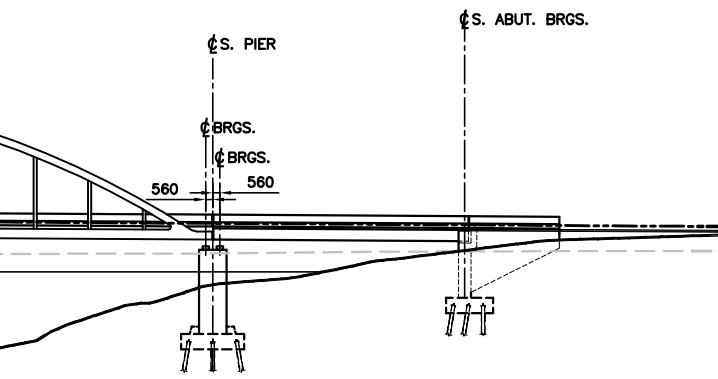

CONCEPTUAL DRAWING  
NOT FOR CONSTRUCTION

- Waterproofing would be elastomeric type cold applied waterproofing in the traffic lanes and beneath the infill concrete of the streetcar tracks; this will mitigate leachate of moisture through possible cracks in the deck slab
  - Railings for barriers would be aluminum or similar corrosion resistant material (stainless steel);
  - Deck drains would be fabricated from stainless steel;
  - Expansion joint cover plates would be fabricated from “raised profile” stainless steel checkered plate of similar slip resistant stainless steel plate;
  - Concrete in the deck, sidewalks and barriers would have a minimum compressive strength of 35 MPa, CSA Class C-1 for all concrete (less than 1500 coulombs chloride ion penetration at 56 days);
  - Siloxane sealer with acrylic based top coat (2 coats) for substructure and exterior faces of barriers and exterior girders;
  - Steel in arch spans would be painted;
  - Interior of steel sections, which cannot be coated, would be hermetically sealed.
- bars;
  - Deck would be waterproofed (elastomeric spray applied);
  - TTC right-of-way would have infill concrete for depth of rail plus anchor plate (200 mm assumed) this needs to be confirmed by TTC during design;
  - Cross fall on TTC right-of-way would be flat;
  - Foundations would be H-piles or equivalent deep foundation type units advanced to rock. Underside of pile cap would be below depth of probable scour or protected by sheet pile;
  - Dewatering will be required to depth to permit placement of concrete in dry or placement of tremie concrete would be required;
  - Will require a drainage system on deck to either discharge directly into the valley or the system will have to be piped to the abutments and into the storm sewer system or some land based treatment facility;
  - Glass fibre reinforced polymer (GFRP) reinforcing bars can be used as alternative to stainless steel in barrier and sidewalk but not in deck without prior approval of the City.

As noted above, this bridge could be built in stages as required, however the entire substructure component may be constructed at the outset, if there is a benefit to permits/ approvals or disruption/ disturbance to the natural environment.

Additional notes for South Cherry Street Bridge are as follows:

- $f'_c$  deck/remaining concrete 35 mPa;
- City of Toronto’s current standards is to use stainless steel reinforcing in the barriers, sidewalk and at least the top layer of reinforcing steel in the deck. Substructure would be standards black reinforcing steel

### 2.1.2.3 Commissioners Street Bridge

Figure 6.9 within the 2014 LDL EAMP Addendum & ESR exhibits Commissioners Street Bridge Redesign.

No significant changes to Commissioners Street Bridge have occurred since 2014.

The bridge shown in **Figure 2-5** has a five (5) span slab on reinforced concrete girder superstructure. The spans are 30 m each for a total length from abutment to abutment of 150 m.

The girders are NU (Nebraska University) 1200 girders at spaces from 2000 to 3000 mm,

depending on the deck usage above. The girders would be semi-continuous for live load and would be integral the abutments.

The substructure piers would consist of deep foundation units made integral with the pier cap as discrete units.

The type of foundation unit is yet to be determined.

The pier shaft and cap would be cast integral with the deck slab, thereby reducing the number of required deep foundation units. The abutments would be integral with the deck, eliminating the need for expansion joints. TTC will need to be consulted as to the viability of having no expansion joints.

The proposed deck cross section will consist of the following:

North

TL-2 Barrier with Railing	300 mm
Sidewalk	4,000 mm
Westbound Traffic	4,800 mm
Eastbound Traffic	4,800 mm
Barrier and Median	2,400 mm
Westbound Transit Lane	3,500 mm
Eastbound Transit Lane	3,500 mm
Median	2,400 mm
Bike Lane	4,000 mm
Sidewalk	4,000 mm
TL-2 Barrier with Railing	300 mm

South

The total deck width is 34,000 mm.

Cross fall for the traffic lanes and bicycle lane would be 2% to the north, with drainage provided at the north curb. The north sidewalk would also drain at 2% to the south (toward the same deck drains).

The bicycle lane and traffic lanes would have 80 mm of asphalt over 10 mm of waterproofing and protection board.

The two transit track right-of-ways would be constructed with no cross fall for transit operational reasons (TTC needs to confirm this is correct). It has been assumed the rails would be anchored to the deck slab with infill concrete placed around the rails once they are properly designed.

Drains for the south portion of the bridge would be placed next to the curb and collect drainage from the sidewalk and transit right-of-way at the location of transverse “trench type” drains.

The proposed durability strategy would be as follows:

- Use stainless steel in the top mat of deck reinforcing; similar corrosion resistant reinforcing material would be used in the sidewalks and barriers;
- Waterproofing would be elastomeric type cold applied waterproofing in the traffic lanes and beneath the infill concrete of the streetcar tracks; this will mitigate leachate of moisture through possible cracks in the deck slab;
- Railings for barriers would be aluminum or similar corrosion resistant material (stainless steel);
- Deck drains would be fabricated from stainless steel;
- Expansion joint cover plates would be fabricated from “raised profile” stainless steel checkered plate of similar slip resistant stainless steel plate;
- Concrete in the deck, sidewalks and barriers would have a minimum compressive strength of 35 MPa, CSA Class C-1 for all concrete (less than 1500 coulombs chloride ion penetration at 56 days);
- Siloxane sealer with acrylic based top coat

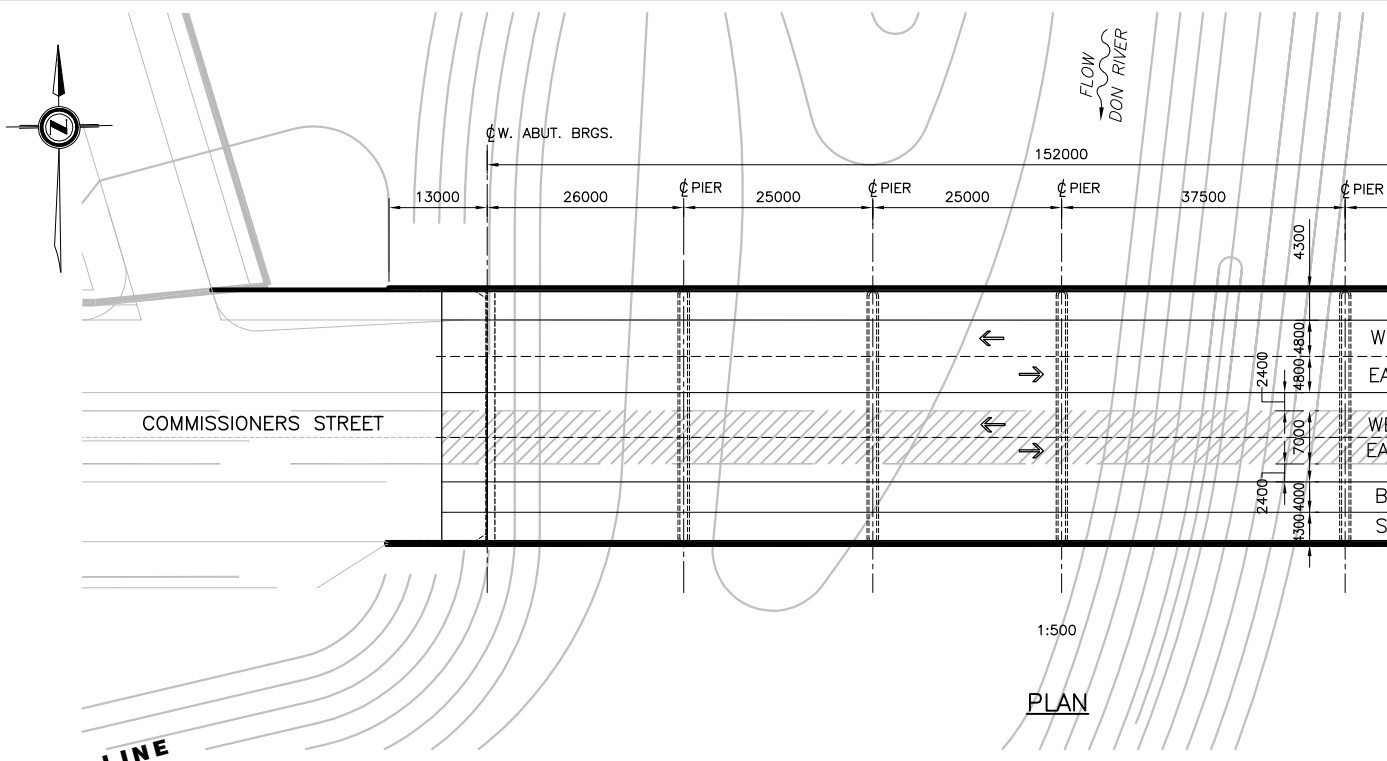

LINE

PLAN

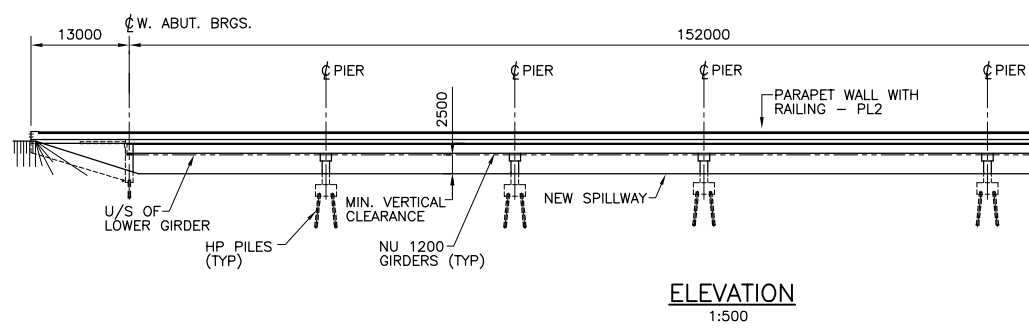

ELEVATION

1:500

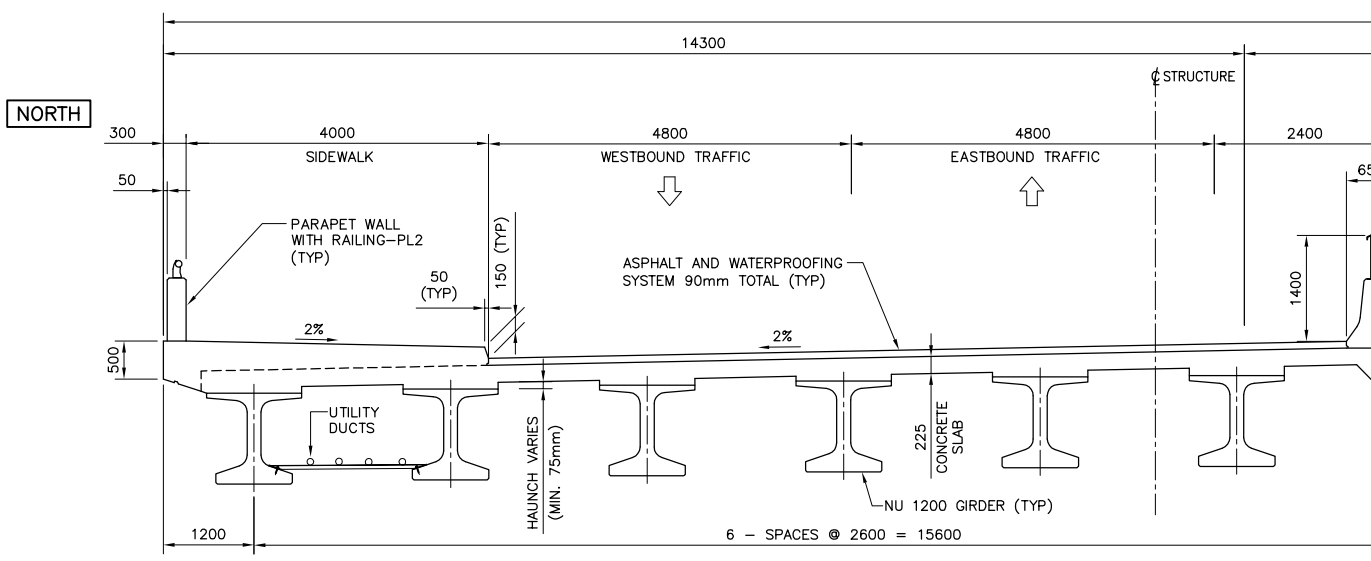

1 TYPICAL CROSS SECTION  
1:50

FIGURE 2-5: Commissioners Street Bridge Redesign

LOWER DON LANDS  
 COMMISSIONER STREET BRIDGE

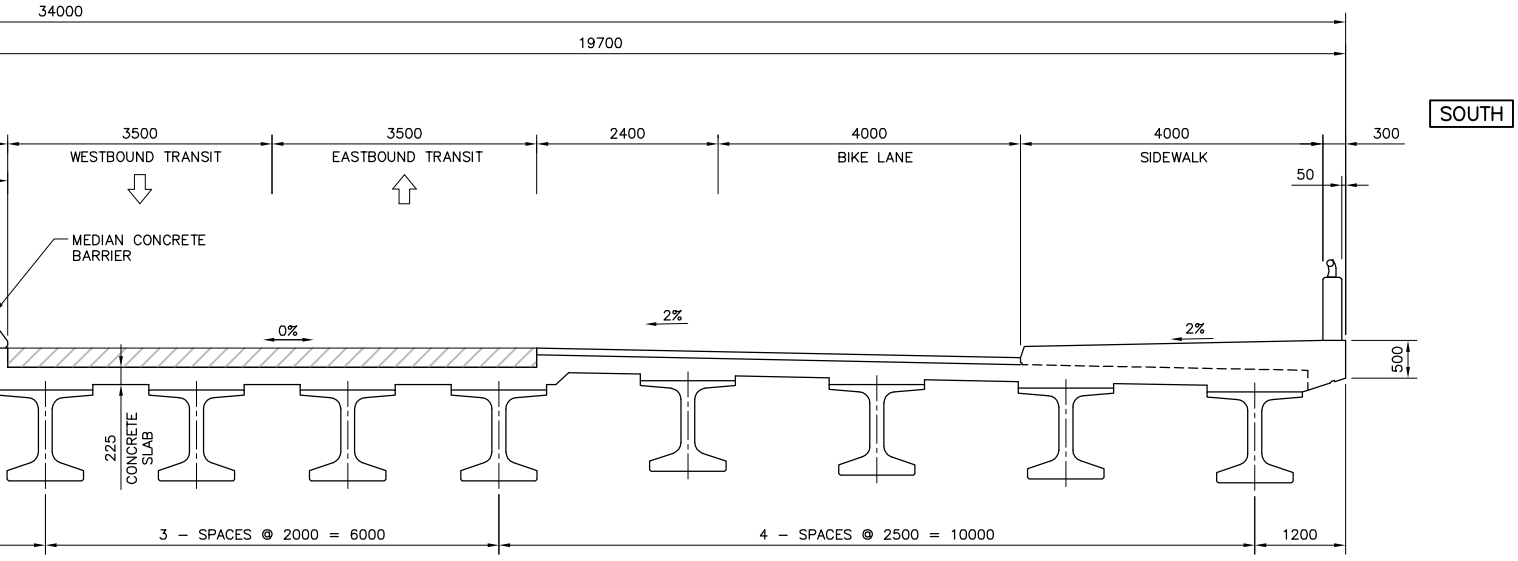
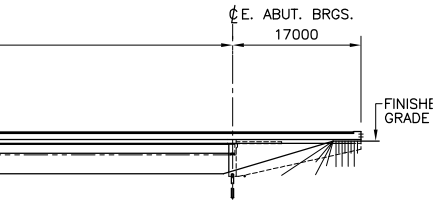
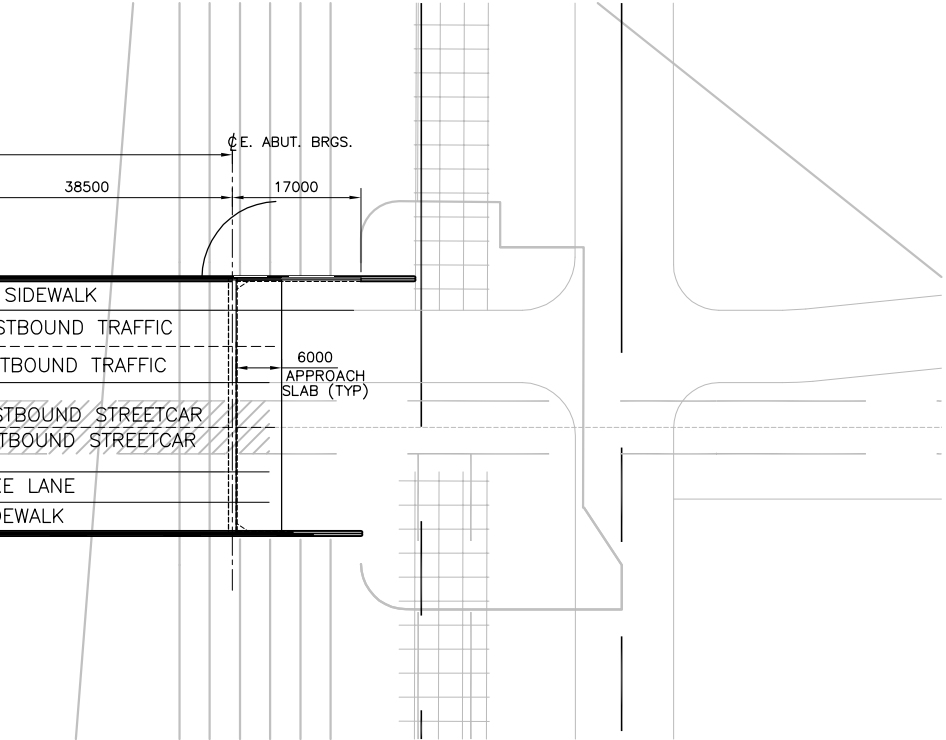

CONCEPTUAL DRAWING  
 NOT FOR CONSTRUCTION

(2 coats) for substructure and exterior faces of barriers and exterior girders.

This bridge could be built in stages as required, however the entire substructure component may be constructed at the outset, if there is a benefit to permits/approvals or disruption/disturbance to the natural environment.

Additional notes for Commissioners Street Bridge are as follows:

- Cross section as shown in typical section;
- Use NU (Nebraska University) 1200 girders (with 140 to 185 web thickness);
- f'c girders 70 mPa;
- f'c deck/remaining concrete 35 mPa;
- City of Toronto's current standards is to use stainless steel reinforcing in the barriers, sidewalk and at least the top layer of reinforcing steel in the deck. Substructure would be standards black reinforcing steel bars;
- Bridge would be fully integral (no expansion joints); would need to discuss with TTC;
- Deck would be waterproofed (elastomeric spray applied);
- TTC right-of-way would have infill concrete for depth of rail plus anchor plate (200 mm assumed);
- Cross fall on TTC right-of-way would be flat;
- Foundations would be H-piles or equivalent deep foundation type units advanced to rock. Underside of pile cap would be below depth of probable scour or protected by sheet pile;
- Dewatering will be required to depth to permit placement of concrete in dry or placement of tremie concrete;
- Will require a drainage system on deck to either discharge directly into the valley or the system will have to be piped to the

abutments and into the storm sewer system or some land based treatment facility;

Glass fibre reinforced polymer (GFRP) reinforcing bars can be used as alternative to stainless steel in barrier and sidewalk but not in deck without prior approval of the City.

#### 2.1.2.4 Basin Street Bridge

The bridge shown in **Figure 2-6** has a six (6) span cast-in-place reinforced concrete superstructure. The spans are each 20 m, when measured perpendicular to the centre line of the road. Due to the curvature of the bridge, the skew span varies.

It would be preferred from a bridge design and function, to eliminate the double curve from the bridge. If this cannot be done, then the proposed structure should yield satisfactory results.

The cast-in-place alternative is proposed due to the need to form the curve deck. This makes the superstructure less suitable for a girder type bridge. Also, given there is no channel existing at the time of construction, falsework for the bridge is feasible (supported on mud sills, on grade). This structure type is also relatively shallow and economic to construct. It also adapts to the changing super-elevation due to the road alignment.

The substructure piers would consist of deep foundation units made integral with the pier cap. The type of foundation has yet to be determined. The pier cap and foundation unit would not be cast integral with the deck. Bearings would be placed between the superstructure and the piers to allow for the articulation of the unique superstructure alignment.

Bearings will be pot or disc type to provide the necessary articulation of the superstructure.

The proposed deck cross section will consist of the following:



North

TL-2 Barrier with Railing	300 mm
Sidewalk	4,000 mm
Westbound Bicycle Lane	1,500 mm
Westbound Lane	3,500 mm
Eastbound Lane	3,500 mm
Eastbound Bicycle Lane	1,500 mm
Sidewalk	4,000 mm
TL-2 Barrier with Railing	300 mm

South

The width of the deck (perpendicular to the centre line of Basin Street) is 18,600 mm.

As the super-elevation on the roadway will vary, the need and spacing of deck drains will be reviewed during detailed design.

The traveled portion of the deck will be protected by 80 mm of asphalt over elastomeric type waterproofing.

The bridge will be investigated during detailed design for the possible use of expansion joints due to the unique curvature. It has been assumed at this point in the conceptual design that the bridge will have expansion joints at the abutments.

Street lights can be installed on the bridge if they are determined to be required at the time of the detailed design. A total of five (5) light poles should be assumed at this point in the preliminary design. Conduits for the street lights can be cast aside the barrier wall or surface mounted (as is the City's standards).

The proposed durability strategy for the bridge would be as follows:

- Use stainless steel in the top mat of deck reinforcing; similar corrosion resistant reinforcing material would be used in the sidewalks and barriers;

- Waterproofing would be elastomeric type cold applied waterproofing in the traffic lanes and beneath the infill concrete of the streetcar tracks; this will mitigate leachate of moisture through the deck slab;
- Railings for barriers would be aluminum or similar corrosion resistant material (stainless steel);
- Deck drains would be fabricated from stainless steel;
- Expansion joint cover plates would be fabricated from "raised profile" stainless steel checkered plate of similar slip resistant stainless steel plate;
- Concrete in the deck, sidewalks and barriers would have a minimum compressive strength of 35 MPa, CSA Class C-1 for all concrete (less than 1500 coulombs chloride ion penetration at 56 days);
- Siloxane sealer with acrylic based top coat (2 coats) for substructure and exterior faces of barriers and cast-in-place deck.
- Additional notes for the Basin Street Bridge include the following:
  - Cross section as shown in typical section;
  - Given the "S" shaped appearance for the structure and the fact that the bridge will be constructed over "dry ground" we would suggest consideration be given to using a cast-in-place reinforced concrete slab bridge. This will also be well suited to the variable super elevation along the bridge;
  - Assumed cast-in-place normally reinforced deck without voids; no post tensioning;
  - Current assumption would be for non-integral design at the abutments with bearings at the abutments and piers;
  - $f'c$  (of all concrete) 35 mPa;
  - Apply City's current standard for use of stainless steel;

CAD FILE LOCATION AND NAME: S:\2015\10\1015073\310\1015073-310-001GA.dwg  
 MODIFIED: 10/14/2015 8:04:30 PM BY: PENNYG  
 DATE PLOTTED: 10/14/2015 8:05:28 PM BY: GREG PENNY

MINISTRY OF TRANSPORTATION, ONTARIO  
 PR-D-707  
 BB-05  
 PLOT SCALE: 1:1

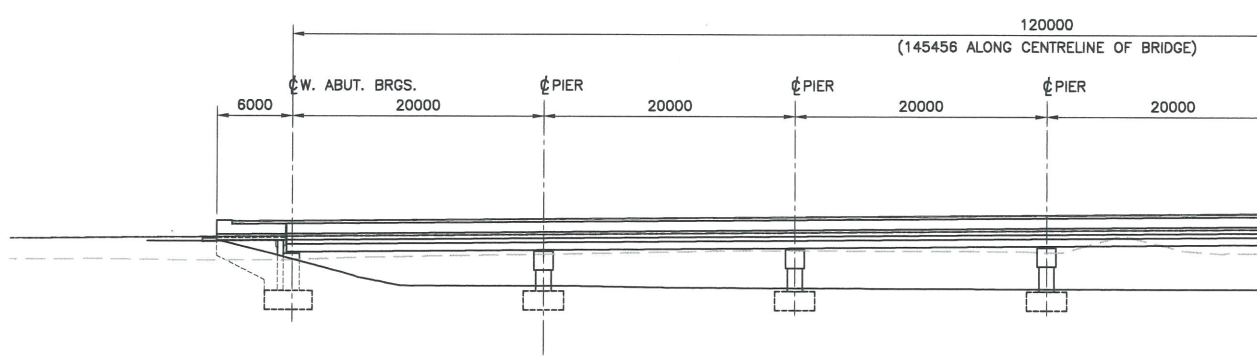
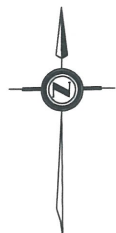

**DON RIVER**

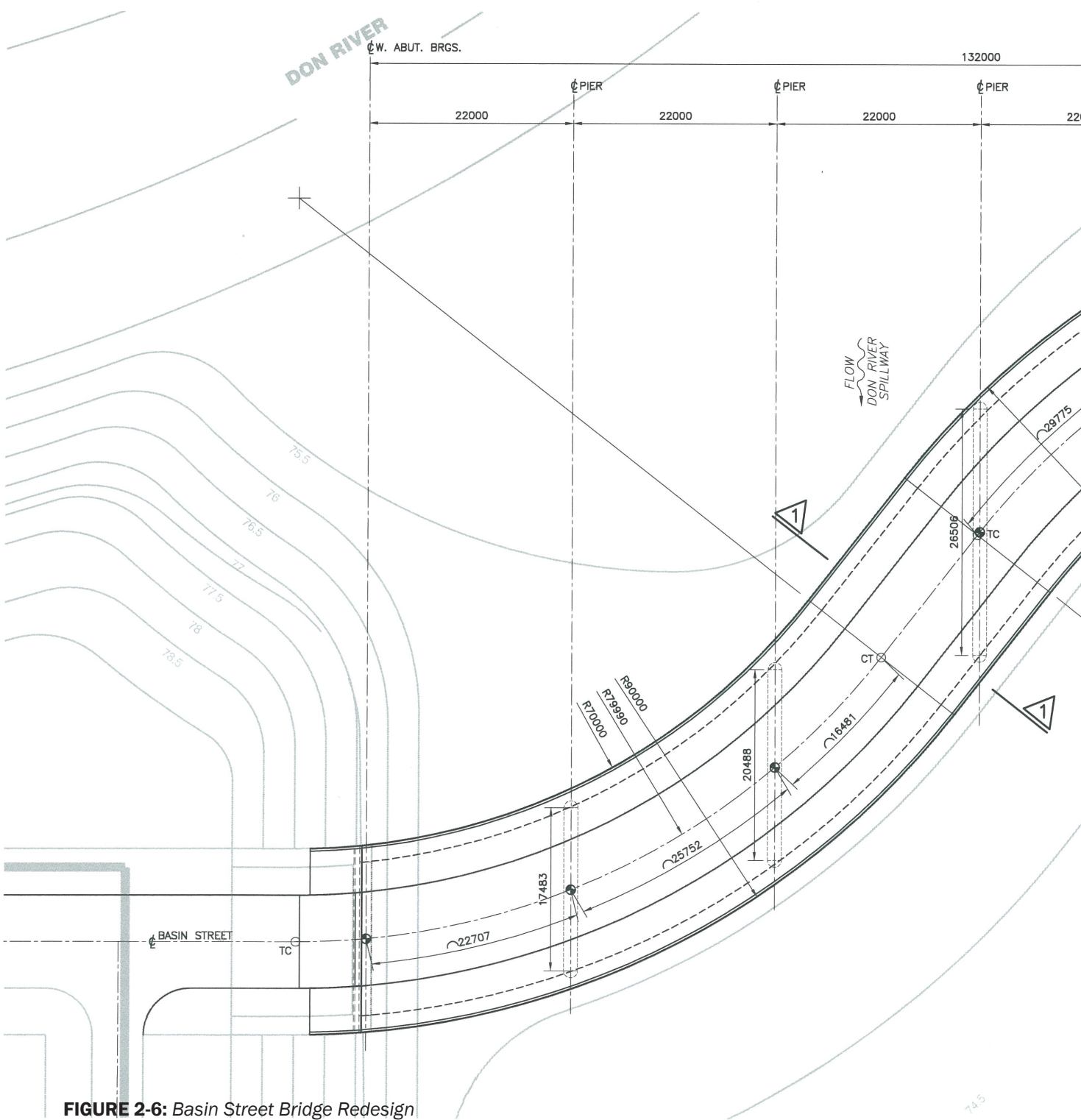
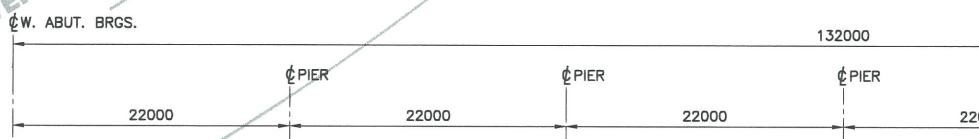

**FIGURE 2-6: Basin Street Bridge Redesign**

LOWER DON LANDS  
BASIN STREET BRIDGE

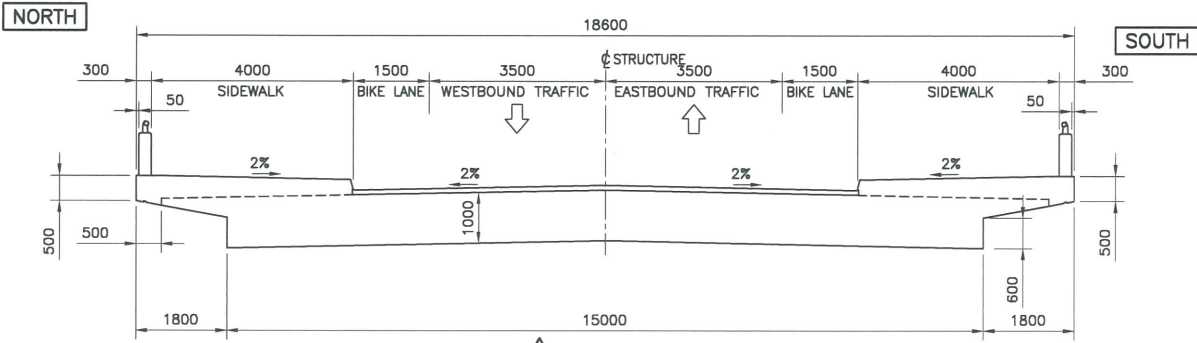
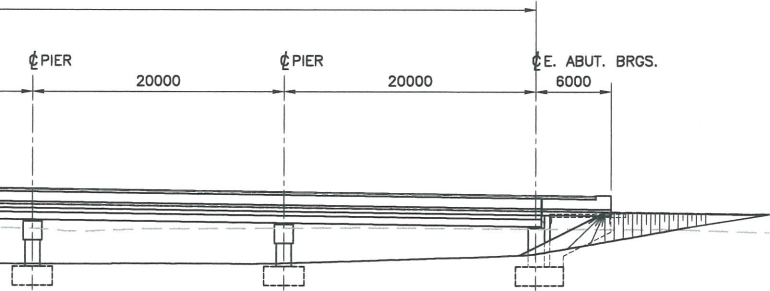

CROSS SECTION  
 1:75

CONCEPTUAL DRAWING  
NOT FOR CONSTRUCTION

- Deck would be waterproofed using elastomeric cold applied waterproofing;
- Substructure would be driven pipe piles (cleaned out and filled with concrete); end bearing on rock. There would be no dewatering if the piles are allowed to be the vertical components of the bent. A cast-in-place cap beam would be constructed with the piles “built into” the cap. This will reduce/minimize the cost of the substructure;
- A drainage system will be required unless discharge into this reach is acceptable to the Conservation Authority. With the entire 10 m wide deck draining to one curb due to super elevation it is believed that multiple curb drains will be required;
- As with Commissioner Street Bridge, GFRP reinforcement can be considered for barriers and sidewalks.

### 2.1.2.5 Munition Street Bridge

Figure 15-11 within the 2010 LDL ESR exhibits Preferred Munition Street Bridge Concept Design.

To evaluate the bridge in the Due Diligence phase, two (2) options were considered. The first is a tied arch with vertical hangers. The second is a tied network arch with the deck supported by cables/tendons.

The cross section/details for the span shown are consistent with the tied arch with vertical hangers. The network arch could be nominally thinner in the cross section.

To achieve a more dramatic appearance, it is feasible to incline the arches inward or outward 15° (or more) from the vertical.

The proposed arches, ties and floor beams would be coated steel. The deck slab would rest on the floor beams and be 225 mm thick, reinforced concrete. The deck would be covered by 80 mm asphalt and waterproofing in

the travelled lanes.

The substructure would be constructed on deep foundation units behind the existing or new dock walls. These would be tied back to provide stability to forces in the direction of the span of the bridge.

Bearings would be located at the four (4) corners of the arch span.

The proposed deck cross section will consist of the following:

#### West Arch

TL-2 Barrier with Railing	300 mm
Sidewalk	4,000 mm
Southbound Lane	3,500 mm
Turning Lane	3,000 mm
Northbound Lane	3,500 mm
Separation Curb	500 mm
Bi-Direction Bicycle Facility	3,000 mm
TL-2 Barrier with Bicycle Height Railing	300 mm

#### East Arch

The total width of the deck is 18,100 mm. It is possible to move the arches from the exterior and with some modifications, place them beside the roadway. This may reduce the overall depth of the structure.

The rise of the arch has been assumed to be 15% of the span. The hangers have been assumed to be stainless steel bridge stand or stainless steel rods. Alternatively, high strength steel rods or strand with double corrosion protection could be used.

A network arch may require some bracing between the arch ribs to achieve the maximum economy.

The proposed durability strategy would be as follows:

- Use stainless steel in the top mat of deck reinforcing; similar corrosion resistant reinforcing material would be used in the sidewalks and barriers;
- Waterproofing would be elastomeric type cold applied waterproofing in the traffic lanes and beneath the infill concrete of the streetcar tracks; this will mitigate leachate of moisture through the deck slab;
- Railings for barriers would be aluminum or similar corrosion resistant material (stainless steel);
- Deck drains would be fabricated from stainless steel;
- Expansion joint cover plates would be fabricated from “raised profile” stainless steel checkered plate of similar slip resistant stainless steel plate;
- Concrete in the deck, sidewalks and barriers would have a minimum compressive strength of 35 MPa, CSA Class C-1 for all concrete (less than 1500 coulombs chloride ion penetration at 56 days);
- Siloxane sealer with acrylic based top coat (2 coats) for substructure and exterior faces of barriers;
- The structural steel would be coated to protect it from corrosion. The interior of sections which cannot be coated would be hermetically sealed;
- Coating would be shop applied with field touch-up.

#### **2.1.2.6 Trinity Street Footbridge**

Figure 15-13 within the 2010 LDL ESR exhibits Preferred Trinity Street Footbridge Concept Design.

No significant changes to Trinity Street Footbridge have occurred since 2014.

#### **2.1.2.7 Keating Channel Footbridge**

Figure 15-10 within the 2010 LDL ESR exhibits Preferred Keating Channel Footbridge Concept Design.

No significant changes to Keating Channel Footbridge have occurred since 2014.

#### **2.1.2.8 Lake Shore Blvd. Crossing**

Section 6.6.2.3 of the 2014 DMNP EAR describes the lengthening proposed for the Lake Shore Boulevard Crossing. Table 6-3 of section 6.3 outlines the flood risk associated with the current crossing configuration, and explains the necessary modifications. No significant changes have been made to this strategy since 2014. The recent approval of the Gardiner Hybrid strategy provides the opportunity to study further modifications to this bridge in the future based on a scenario where the elevated Gardiner is removed from above the Lake Shore Boulevard crossing. The design and flood conveyance impacts of this approach will be studied in detail design work, once more detailed information is available for the proposed Gardiner design.

### **2.1.3 TRANSIT NETWORKS**

Refer to Chapter 6 and Section 6.1.11 in the O14 LDL EAMP Addendum & ESR, and Sections 10.1.1, 11, 15.1 of the 2010 LDL ESR for a description of the proposed Transit Network for the project area. No significant changes have been made to the proposed transit networks since 2014.

## **2.2 WATER / WASTE WATER**

### **2.2.1 WATER DISTRIBUTION NETWORK**

The Lower Don Lands will be serviced by extending existing municipal watermains from adjacent rights-of-way into the precinct, as previously established through the Environmental Assessment. A looped connection from existing watermains will be

provided from Cherry Street at the Keating Channel, Don Roadway, and Commissioner's Street as part of the development of the precinct. A watermain crossing of the new river channel between Commissioners Street and Polson Street will be implemented to maintain service to the Polson Island. Ultimately, additional connections from Cherry Street and the Don Roadway at the Ship Channel, and Basin Street, will be provided.

The sizing of the new watermains will be in accordance with the EA; generally a 400 mm PVC watermain will supply a series of 300 mm PVC watermains throughout the district. Watermains will be installed at minimum cover (1.7 m) to comply with City of Toronto design standards where possible; river/spillway crossings will be installed via horizontal directional drilling. Due to installation within engineered fill, all new watermains and connections to existing will require mechanically restrained joints. Line valves will be required at all intersections in compliance with City of Toronto design specifications. The phasing for the water distribution system to identify the core servicing and the development related servicing will be further defined as part of the schematic design.

Watermains will be installed north of Commissioners Street to Villiers Street adjacent to the new river channel and west of Cherry Street along the Commissioners Street alignment so that existing building to be remain can be serviced.

Chemical compatibility of soils and PVC watermains will need to be confirmed in future design phases. Based on anticipated types on contaminants in un-tested areas of the site, PVC Type II may not be suitable. PVC Type I, or the use of lined trenches or utilidors may be required.

Figure 7.1 within the 2014 LDL EAMP

Addendum & ESR documents latest changes to Water Supply Infrastructure.

### **2.2.1.1 Fire Protection**

The new rights-of-way will require hydrants to be located to further than 90 m spacing in order to confer fire protection on development blocks. New buildings will need to site their Siamese connections within 45 m of a fire hydrant as mandated by the Ontario Building Code, or provide new hydrants to comply with the OBC. Existing watermains will be maintained adjacent to the existing building that will remain with the required hydrant coverage.

### **2.2.2 SANITARY SERVICING**

The Lower Don Lands will require a new municipal sanitary sewer network to convey wastewater from development blocks to a new pumping station; this strategy was established through the Environmental Assessment, subsequent EA Amendment, and the Port Lands Acceleration Initiative. The new pumping station will lift wastewater to the gravity sewer system in Lake Shore Boulevard which flows east to Logan Avenue, and north to the Ashbridges Bay treatment facility.

The core wastewater collection system will provide for gravity sewers flowing from west to east along Commissioners Street with a crossing of the new river channel to the Don Roadway. The new gravity system will then follow Commissioners Street east of the Don Roadway to the intersection of Saulter Street. At this location a new sanitary pump station will be installed and a new sanitary forcemain implemented to convey the effluent to the intersection of the Don Roadway and Lakeshore Boulevard. In general the pipe sizes will range from 250 mm to 375 mm.

To Service the Polson Island and the existing structures to remain south of the river channel, a new sanitary sewer will be installed along Polson Street to a new crossing of the river

channel. The river channel crossing will be implemented with a micro-tunnel installation. Sanitary sewers will also be installed north of Commissioners Street to Villiers Street adjacent to the new river channel and west of Cherry Street along the Commissioners Street alignment so that existing buildings to the north can be serviced. The depth of the new sewers will range from approximately 2.5m to 12m at the river crossings

All sewers will be approved PVC and constructed to comply with City of Toronto design standards; it can be assumed that maintenance hole spacing will be approximately 100 m. The phasing for the sanitary system to identify the core servicing and the development related servicing will be further defined as part of the schematic design. The layout and alignment of servicing will be further refined in future design phases with consideration given to site conditions as more information becomes available. Layout and alignment will need to respond to any limitations determined to result from existing below-grade conditions on site.

Figure 7.2 within the 2014 LDL EAMP Addendum & ESR documents latest changes to Sanitary Sewer.

### **2.2.2.1. Commissioner's Street Pumping Station**

A general description of the proposed Commissioner's Street Sewage Pumping Station is outlined below. Please note that the sanitary pump station criteria relates to proposed development relates flows. Phasing of the pump station to accommodate core servicing and development horizons will be reviewed as part of the schematic design.

The location of the sanitary pump station is currently shown at the intersection of Commissioners Street and Saulter Street. There will be a deep crossing of the Valley Wall Feature with the new sanitary sewer that will be reviewed with the TRCA in more detail.

- Separate two compartment raw sewage wet well, equipment dry well and at-grade building structure with an estimated 12m by 15m footprint complete with separate dedicated rooms housed in a brick, stone and or siding clad building superstructure located above the below-grade wet well sub-structure;
- Four equal-capacity variable speed pumps to provide ultimate firm capacity of approximately 150 L/s (to be confirmed during Stage 2). Firm capacity will be based on total available pumping capacity with the largest pump out of service. Initially two/three/four pumps will be installed to operate duty / standby and meet peak flow requirement during initial operating period, pumping north to existing Lake Shore Boulevard sanitary sewers tributary to the Low Level Interceptor (LLI);
- Pumping Station superstructure comprising control and equipment rooms containing maintenance bay, electrical switchgear, MCC, Controls and Instrumentation, odour control system, SCADA and diesel generator set for emergency power rated at approximately 400 kW standby rating. A permanent diesel engine generator with ultra-low emissions rating and radiator cooling housed in generator room with noise suppression features and sized to provide power for the peak pumping rate and most control building electrical use requirements including approximately 30% of HVAC loads;
- Separate at-grade entrances for the dry well, generator and control rooms to isolate electrical equipment in control room from other classified areas;
- Separate water and gas-tight hatch entrances into the sewage wet well for confined-space entry and equipment access all in compliance with City of Toronto H&S requirements. Personnel access openings are sized to permit the entry of personnel

wearing air pack, retrieval equipment harness and designed to permit movement of personnel without disconnection of safety line into the lowest level of the wet well (approximately 3.5 m below incoming wastewater invert);

- Provide a minimum of 1m clear space around pumps, process valves and generator for servicing;
- Access openings for pumps in the dry well are sized to permit for pump installation and removal and to permit the entry of personnel wearing retrieval equipment harness and designed to permit movement of personnel without disconnection of safety line and provide exterior surface access hatch;
- A suction pipe with Camlock to facilitate evacuating sewage from wet wells by a portable submersible pump or by vacuum truck and separate large-capacity by-pass connection in/out pumping station;
- Washroom facility and separate tepid water emergency shower system;
- Property redevelopment designed to integrate into the surrounding lands and nearby river/lake/harbour interface zone, provide access to pumping station including during extreme flood events and incorporate storm water management features as required;
- Pump discharge forcemain system comprising either single 350mm forcemain or optional dual 300mm forcemain system running 280m in a northerly direction to a discharge chamber on the LLI.
- The pump station will be located appropriately for operational needs, and avoid detrimental interference with the VWF core, following the Don Roadway.

### **2.2.3 STORM SERVICING**

A new stormwater conveyance system will be required as part of the core infrastructure for the Lower Don Lands Redevelopment. There are two forms of stormwater conveyance systems that will be implemented as part of this redevelopment, the minor system and the major system. The minor system will be designed to accommodate stormwater runoff from a 2-year rainfall intensity return period and will be conveyed in a series of underground sewers. The major system will be designed to accommodate stormwater runoff up to the 100-year rainfall intensity return period, and will be conveyed overland, primarily along the new roadway system to approved outlet points.

#### **2.2.3.1 Minor Storm System**

The Approved EA for the Lower Don Lands has defined a minor storm system for roof top drainage and a separate minor system for at grade drainage. The roof top system will be implemented for selected development blocks and will outlet to the wetland areas along the new river channel. The non-rooftop system, including the municipal roadways, will outlet to a new stormwater management facility.

For the individual blocks that form part of the roof top drainage system, there will be a specific storm sewer connection to the Block with a control maintenance hole at the property line. Only stormwater discharge from the roof top will be permitted to connect to this service connection. The roof top areas will have flow control roof drains to attenuate the peak flows and store water on the roof tops to outlet at a controlled rate. The storm service connections will cross the fronting municipal roadway to the new river channel and outlet to a subsurface gravel seam along the seepage wetlands. Each development block with roof top drainage to the wetlands will have a separate storm service connection as defined above. The gravel seam that accepts the roof top drainage is a



subsurface gravel storage area that will extend along the full length of the seepage wetland. The gravel seam will be set at a common elevation so that the stormwater will rise in the gravel storage area and have a distributed outlet to the wetland along its full length.

The minor drainage from the non-rooftop areas will be conveyed in a standard municipal storm sewer system. New municipal storm sewers will be required along all of the core roadways including Cherry Street, Commissioners Street and the Don Roadway. Drainage from the roadway systems will be collected in catchbasins that typically have an approximate 30 m separation along the roadways. Storm drainage from the development blocks will be collected via storm service connections to the blocks with control maintenance holes at the property lines. The development blocks that already have storm service connections for the roof top system will require a second storm service connection for the at grade drainage within the block.

Storm drainage from non-rooftop areas will outlet to a new Ballasted Flocculation Facility (BFF) for stormwater treatment prior to outlet to the lake. The BFF is schematically located at the north east corner of Villiers Island. Alternate locations for the BFF are being considered. This BFF is intended to receive drainage from the Lower Don Lands area south of the Keating Channel, north of the Ship Channel and west of The Don Roadway. The phased implementation of the BFF will be reviewed as part of schematic design. The core Villiers system will run south along Cherry Street and east along Commissioners Street. The Polson system will ultimately run north along Cherry Street and east along Polson Street. Drainage from the block developments and roadway systems outside of the core system will connect to the new municipal sewers. The new core gravity sewer systems will be constructed as part of the new roadway systems with maintenance holes at approximate 100m

spacing. The new sewers will also form part of the new roadway environmentally clean roadway section and will be approximately 3.0m to 6.0m deep. A new storm sewer river crossing between Polson Street and Commissioners Street will be installed as part of the core servicing to provide future service to the Polson Island.

The crossing is identified at the east end of the development area and is anticipated to be a micro tunnel installation. The depth of the tunnel will be approximately 10m with a 2.0m to 3.0m diameter. The tunnel will extend north from the Polson Quay to the proposed BFF location. The BFF and UV treatment of the stormwater is at grade, so a pump station and shaft is required to lift the stormwater from the tunnel to the treatment facility. Stormwater attenuation and storage is also required so that a steady release rate can be provided to the BFF. It is anticipated that an approximate 12m diameter shaft with associated pumping facilities will be required. Prior to the stormwater entering the storm sewer tunnel, pre-treatment will be applied. It is anticipated that ultimately, one oil grit separator (OGS) will be installed in both the Polson and Villiers Island. The OGS units will be approximately 3.0m in diameter and approximately 7.0m in depth.

It is anticipated that a new minor storm sewer system will be required along the reconstructed length of The Don Roadway. With the Don Roadway located east of the new river channel, the drainage from this roadway will not be conveyed back to the proposed BFF. The Don Roadway drainage will be collected locally through a series of storm sewers and catchbasins and will outlet to the existing Municipal system in this area as per pre-development conditions. Drainage from The Don Roadway will ultimately for part of the Port Lands stormwater management plan. With the Don Roadway forming part of the Valley Wall Flood Protection Feature, the storm

sewer system will be coordinated with TRCA requirements.

The layout and alignment of servicing will be further refined in future design phases with consideration given to site conditions as more information becomes available. Layout and alignment will need to respond to any limitations determined to result from existing below-grade conditions on site.

### **2.2.3.2 Major Stormwater System**

An overland flow route has been established as part of the preliminary grading concept for the Lower Don Lands. The overland flow route provides a path along the surface for major storm events that cannot be accommodated in the below grade sewer system. The overland flow route is generally along the new roadway system and outlets to the Keating Channel, Ship Channel, or lake. Overland flow is established to ensure the development blocks do not flood in a major storm event. As part of the overall Lower Don River design, a new spillway will be constructed at the east limit of the site adjacent to The Don Roadway, and will outlet to the Ship Channel. This new spillway forms part of the major overland flow system for this area and will engage at around the 25 year storm event to protect against flooding. Vent designs will also be incorporated into the seepage wetlands along the new river channel to ensure against washouts in major storm events.

## **2.3 STORMWATER MANAGEMENT**

The Stormwater Management strategy for the Port Lands is based on a more modern approach to runoff management, recognizing the value of source separation of runoff from common, rainwater events compared to rarer, stormwater events. It attempts to install the full mix of source controls, conveyance controls and end of pipe systems that form a robust ‘treatment train’ approach to runoff controls. In effect, it recognizes that common, lower total

depth precipitation events produce manageable volumes of runoff that can be channeled to beneficial uses, while those same collections systems under intense storm events can overflow into storm sewers for treatment and discharge to the Toronto harbour.

The SWM strategy will be required to conform to a framework resulting from a number of policy documents. Primarily, guidelines from the Ministry of Environment and Climate Change require runoff treatment to acceptable water quality standards prior to discharge to the natural environment at flow rates recognizing the character of the receiving water system. For the purposes of the Port Lands system, this boundary will be defined at the water’s edge of the Toronto harbour and the newly created Don River Mouth (and its associated wetlands). Secondly, the City of Toronto has issued a set of Wet Weather Flow Management Guidelines (2006) to guide development inside its jurisdiction, including requirements for water quantity control, quality treatment, water balance and erosion control. Each item will be discussed below.

1. Water Quantity Control: Primarily related to control elements needed to store uncontrolled runoff and discharge it at controlled rates to downstream handling systems. In typical situations, runoff flow rates are required to be controlled to rates that respect the conveyance capacity of the receiving system, such as a natural watercourse or a potentially overcapacity storm sewer network. In the case of the Port Lands, the storm sewer system (minor drainage system) and the overflow surface grading (major drainage system) needed to channelize high volume discharges resulting from rare storm events are entirely new systems, and capable of being designed and constructed with sufficient capacity to convey all anticipated flows (up to and including resulting from the 100 year

event) to the Toronto harbour, which is not sensitive to any increased flow rates. Thus, there is no actual requirement for water quantity control in the Port Lands system. In effect, each area of the Port Lands will be serviced by a minor drainage system consistent with the storm servicing requirements of the City of Toronto, with a major flow system available to convey overflows within the public rights of way fully to the limit of the harbour. Additional storage and flow control would not be useful or recommended as the sensitive systems the policies are designed to protect are not present in the development.

2. Water Quality Control: Policies guiding the acceptable level of water quality required for discharge to receiving waters are designed to ensure the recipient environment is protected from the effects of development in the total concentration of pollutants rinsed from them. The Port Lands will be developed in a Master planned system, with the ability to separate clean sources of runoff from areas that aggregate pollutants during inter-precipitation periods. Rooftops surfaces are typically sufficiently clean for direct discharge to sensitive receivers. The Port Lands will incorporate a rooftop runoff collection system designed to support 'seepage' wetlands with the cleanest runoff sources available. All development blocks adjacent to and supportable by rooftop collection systems will be required to connect rooftop collection downspouts to the collection system. All rooftops connected to the system will incorporate controlled rooftop inlets to provide temporary rooftop storage (typically less than 24 hours of duration) and flow control to ensure the receiving gravel seam storage systems can distribute runoff to the seepage

wetlands in a uniform pattern. Water entering the gravel seam storage beds will discharge to the seepage wetlands over time with overflow to the major flow outlets from the development blocks. Runoff from non-roadway ground areas will be collected in area drain systems inside the development blocks with discharge to the storm sewer systems to mix with drainage from the municipal rights of way. Drainage from roadways and sidewalks inside the municipal rights of way will initially be directed to non-infiltrating 'conveyance' controls such as Modular Wetlands™ or SilvaCell™ systems in the adjacent streets which will mix with collected non-roof development block runoff into the minor drainage system which will discharge to the "Ballasted Flocculation Facility" (BFF) on Villiers Island. More details on this system are provided in later sections, but the BFF system is a compact water quality treatment system that performs the same functions as a Wet Stormwater Management treatment pond, but within a much smaller footprint. This system will be necessary, however, its capacity requirements may be reduced or modified by a judicious application of alternative stormwater Management approaches to development blocks and proper direction of clean sources of runoff away from the minor drainage system.

3. Water Balance: The City of Toronto and Ministry of the Environment require the development blocks to ensure that annual volumes of runoff are maintained to pre-development conditions, with the maximum annual volume of runoff not exceeding 50% of the total annual rainfall. For the Port Lands, this requires the development plan to incorporate destinations for runoff that are not integrated into the storm sewer service

and BFF. The rooftop collection system for the majority of the development blocks is an appropriate 'natural' destination for considerable amounts of annual runoff, and is expected to address this issue for their tributary blocks. Other areas that cannot be serviced by the seepage wetlands will be expected to find sufficient non-potable water uses, such as rainwater harvesting systems, irrigation, or sanitary water offset strategies, to meet the requirements inside the individual blocks. Depending on the amount of rooftops proposed in each block, it is possible that the seepage wetlands, when the rooftop collection system is maximized, may be sufficient to offset the water balance needs for the other blocks, and potentially for the municipal rights of way as well. This is a preferred direction for the various precincts in the Port Lands, but it requires cooperation from all involved parties.

4. Erosion Control: Policies related to permanent erosion control are intended to guide the release of more common precipitation events, such that the long-term erosive energy of discharges from minor storm sewer systems are within the capacities of the receiving systems. The receiving systems for the Port Lands involve one single discharge location (the outlet of the BFF), while there will be numerous major flow discharge locations. The position of the BFF on Villiers Island precinct will site the BFF discharge in the Keating Channel. As the historic outlet for the Don River, this channel is armoured on all sides by sheet pile quays and experiences significant flow rates from the large drainage area that encompasses a substantial portion of Metropolitan Toronto. The new river outlet will split flows between it and the remnant Keating Channel. As such, the addition of flows from the BFF outlet will form a small

fraction of the overall flow capacity of the Keating Channel and as such, additional storage and flow control to address permanent erosion requirements of the Keating Channel are not recommended.

Refer to Fig. 8.1 within the 2014 LDL EAMP Addendum & ESR documents for proposed Stormwater Drainage strategy.

Fig. 8.2 within the 2014 LDL EAMP Addendum & ESR presents the Water Quality Treatment Process. Fig. 8.3 within the 2014 LDL EAMP Addendum & ESR exhibits Potential Discharge Locations for treated/clarified water.

### **2.3.1 KEATING CHANNEL RECIRCULATION**

Flow within Keating Channel is being considered in order to ensure adequate water movement is maintained for desired water quality, and quality of public experience along the future Keating Channel promenade. Direct flow from the Don River into the Keating Channel will be reduced from existing levels by the control weirs. The design team is considering alternatives for supplementing the channel flow with treated stormwater. The current stormwater strategy directs surface water to a BFF for treatment. The design team is considering options for location of the BFF and pump system that would allow treated stormwater to then be pumped into the east end of the Keating Channel. This design will be further developed in the schematic design phase of work, and integrated with the overall site strategy for stormwater.

## **2.4 UTILITIES**

### **2.4.1 EXISTING UTILITIES**

There are a series of existing utilities within the Lower Don Lands area. These utilities include sewers, watermains, hydro, lighting, gas and communications. The existing public utilities are generally located within the existing

municipal roadways including Cherry Street, Polson Street, Commissioners Street, Villiers Street and The Don Roadway.

#### **2.4.2 DECOMMISSIONING EXISTING SERVICES IN COORDINATION WITH PHASED EARTHWORKS**

There are a number of existing Heritage buildings within the Lower Don Lands that will be preserved as part of this development (subject to further analysis). These structures are generally located at the intersection of Villiers Street and Cherry Street as well as along Polson Street west of Cherry Street. The servicing for these structures generally runs along Polson Street, Cherry Street and Villiers Street to a connection point at the intersection on Villiers Street and the Don Roadway. To maintain servicing to the existing heritage structures, the existing services along Polson Street, Cherry Street and Villiers Street will have to be preserved. The initial phases of earthworks can proceed with the servicing protection zone as identified. For the later phases of development, new services have been identified so that the existing structures can be maintained

As discussed in Chapter 5 of this report, the proposed grade raises along the existing road corridors where the utilities are to be protected are anticipated to induce settlement of the underlying site soils. This may result in a need for settlement mitigation measures to protect the existing utilities from potential excessive settlement and damage during the period over which they are to remain in service.

At the time of the Commissioners Street removal and reconstruction, a sanitary by-pass system will be required to maintain an outlet for the existing buildings along Polson Street. To accommodate this sanitary by-pass, a minor sanitary pumping facility will be required at the intersection of Cherry Street and Commissioners Street. This temporary

pump will lift the effluent from the Cherry Street system south of Commissioners to the Cherry Street system north of Commissioners that ultimately drains to the Don Roadway via Villiers Street.

There is an existing municipal storm sewer west of Cherry Street and north of Commissioners Street that will be impacted by the initial phase of proposed earthworks (that is, the in-filling of Essroc Quay). It is proposed to relocate this storm sewer into the servicing protection zone, which will require a new by-pass gravity storm sewer. The new gravity storm sewer will be installed along Cherry Street between Commissioners Street and Villiers Street, as shown. There is an existing storm sewer outlet to the Keating Channel from Villiers Street east of Cherry that is proposed for re-use as part of the by-pass system. Approximately 310m of 600mm diameter by-pass storm sewer will be required, subject to further hydraulic analysis. The main virtue of this temporary storm system would be the preclusion of the requirement for a new or temporary dock wall penetration to provide an outlet for existing storm drainage. This will be reviewed in more detail as part of the Schematic Design.

The majority of existing utilities along Polson Street, Cherry Street and Villiers Street will be decommissioned and removed as part of the new core roadway installations along these alignments. For the existing Cherry Street alignment, the existing utilities that are within future development blocks will be decommissioned and removed as part of the block developments.

#### **2.4.3 PROPOSED UTILITIES**

Toronto Hydro is undertaking a power distribution study for the Lower Don Lands area. This study will define the hydro infrastructure that is required for the proposed redevelopment of this area. It is generally understood that new hydro infrastructure will run along the proposed

roadway alignments. Hydro will dictate these alignments and the other utilities including gas, streetlighting, and communications will follow these alignments in a joint use trench.

# 3 FLOOD PROTECTION

The first four sections within this chapter address flood protection strategies - Flow Control Weir, Spillway and Slope Armouring - developed by MVVA and a team of consultants. The following three sections describe any significant changes to flood protection strategies developed by others for Eastern Avenue Flood Protection, First Gulf Flood Protection Landform, and Don Roadway Valley Wall Feature since the 2010 LDL ESR, 2014 LDL EAMP Addendum & ESR, and 2014 DMNP EAR were released.

## 3.1 GEOMORPHOLOGY AND SLOPE ARMOURING STRATEGIES

### 3.1.1 OVERALL RIVER VALLEY STABILITY

The design team has determined, in collaboration with Waterfront Toronto as well as Toronto and Region Conservation Authority (TRCA), that ecological elements within the river system should be stable through the 50-year flood event, as noted in Section 6.1.3 of the 2014 DMNP EAR. The ecological elements are not required to be stable through the regulatory flood event, rather the design will include buried slope protection at the valley edges, which will resist scour and erosion during the regulatory event. The regulatory event slope protection should be built into proposed valley embankments to protect recreation and developed infrastructure. The placement of the rock protection near to the valley edge will allow for maximum flexibility within the Don River

valley for channel changes and future land use management for recreation.





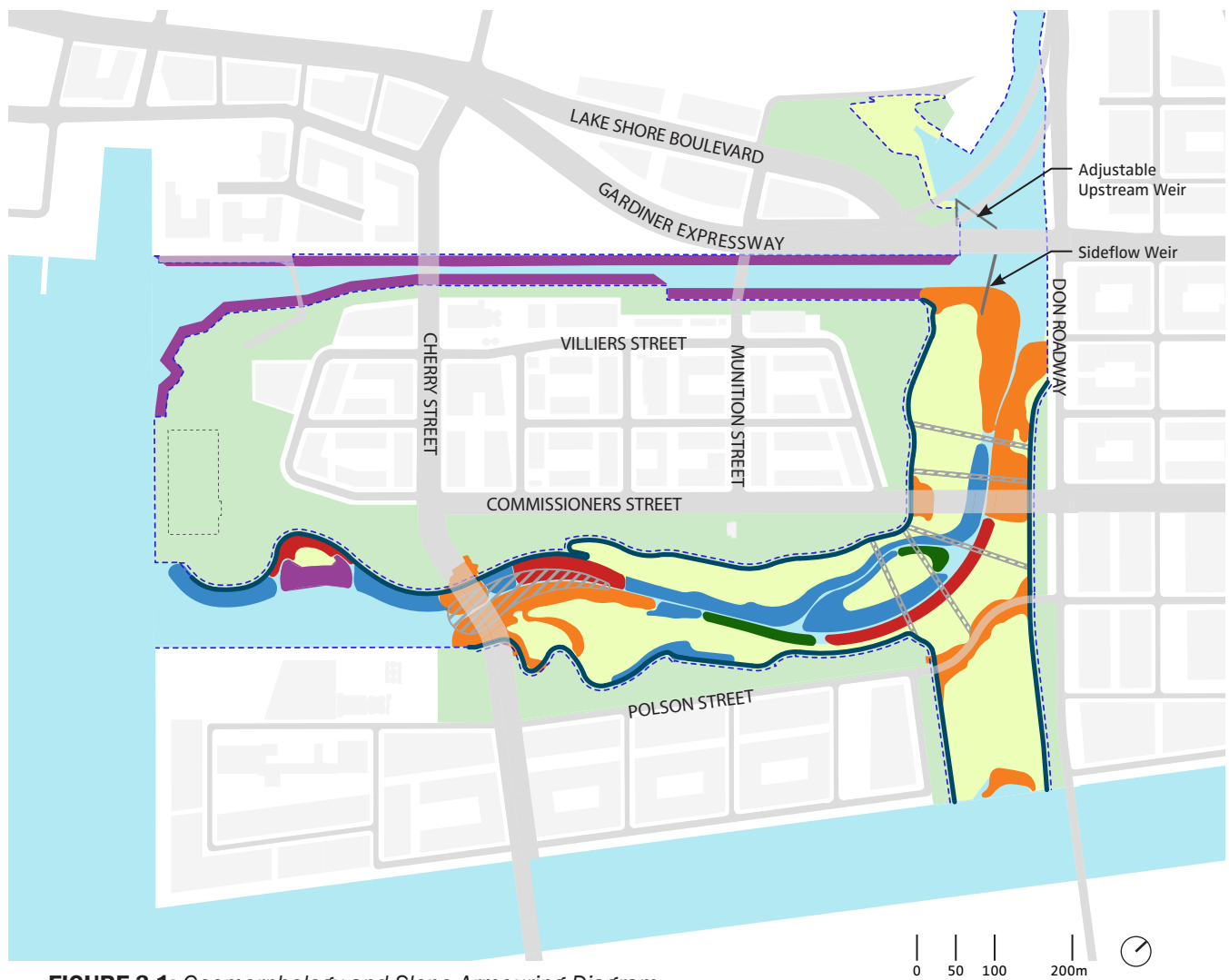





### 3.1.2 RIVER GEOMORPHOLOGY

The output from the 2D hydraulic modeling completed by Limno Tech has been reviewed and integrated into the desktop geomorphic review that has been completed for the proposed design. In addition, historic lake levels have been evaluated and given the proximity of the river reach to the lake, the seasonally changing lake level has been deemed to be the controlling factor for the river system design. Extending the mouth of the Don River out into Lake Ontario requires further engineering and sediment transport analysis in subsequent design stages to ensure that the channel transports the river sediment coming into the project area from upstream. Consequently, the primary factors defining the proposed channel dimensions are sediment conveyance and habitat area. The momentum of the river should be maintained to convey suspended sediment through the project and maintain adequate water quality for fishing, boating, and passive recreational use. The channel dimensions continue to be evaluated based on hydraulic impacts to the regulatory flood conveyance as well as the deposition and sediment conveyance factors referenced above. See **Appendix B** for typical section drawings through the river valley, illustrating the conceptual approach for channel dimensions and armouring.



**FIGURE 3-1:** Geomorphology and Slope Armouring Diagram

**Legend**

- |  |  |  |   |
|--|--|--|---|
|  Bioengineered Bank             |  Gravel Bank              |  Parkland   |  Buried Armor / Sheetpile Wall |
|  Buried Grade Control Structure |  Large Wood Stabilization |  Floodplain |  Regulatory Flood Event Extent |
|  Exposed Armor                  |  Rocky Harbor Edge        |  |   |

**3.1.3 BASE FLOW RIVER CHANNEL SLOPE STABILITY AND DESIGN RECOMMENDATIONS**

The shear stress on the channel and banks of the river system were calculated from the 2D hydrodynamic modeling for a range of flow events, from the 6-month return

period storm to the regulatory flood event. Based on those stresses, and the proposed adjacent infrastructure and uses, a plan has been developed with various strategies for constructing the naturalized channel and armoring the channel bed and adjacent slopes. The areas with the various armoring



treatments are shown in the Geomorphology and Slope Armouring Diagram in **Figure 3-1**. In areas where the shear stresses are shown as the highest, as well as in the ice management area and areas with potential for public access to the water, hard armoring protection is proposed to protect the channel and the banks from erosion. In areas where the bottom of the channel has the potential to erode, particularly with the regulatory flood event, buried grade control structures are proposed to maintain the basic channel elevation and alignment. In other areas, particularly on the inside of the bend, the channel can be protected using bioengineering techniques, which will also serve as naturalized habitat areas.

The recommended general plan for bank construction combines a bioengineered upper bank (above the bankfull flow elevation) with variable toe materials such as gravel, cobble, or large wood. The actual composition of the toe depends on the amount of short term and long term deformability that is allowed within the valley. **Figure 3-1** illustrates the proposed slope armouring diagram for bank construction.

Bioengineered upper banks could include fabric encapsulated soil, soil integrated into geocells, geofiber reinforced soils, or simply graded slopes covered with biodegradable erosion control fabrics. Large wood toe treatments will be focused on the outer bends, or strategic habitat points where hydraulic shear is high enough to scour around wood toe treatments, maintain pools and provide complex large wood associated habitat. Based on the 2D hydraulic modeling completed by Limno Tech, (see **Appendix A** for flood modelling results), most of the site does not exhibit shear stress through the 50-year (or even the 100-year) flood event that would warrant rock or synthetic geotextile installation. Critical areas in the vicinity of the bridge piers, as well as an isolated area upstream of the Cherry Street bridge, will require additional stability based on shear stress exhibited during the regulatory event and

lower flow events such as the 50-year event, as seen in the 2D models. Design for these areas may include sculpted rock treatments, riprap or designs integrating hard toe and upper bank bioengineering. **Figure 3-2** provides an example of a typical soil wrapped slope with large wood in an urban low gradient yet flashy environment, similar to the hydrology of the Don River. **Figure 3-3** and **Figure 3-4** provide



**FIGURE 3-2:** *Example of bioengineered bank*



**FIGURE 3-3:** *Example of exposed armouring*



**FIGURE 3-4:** *Armouring integrated with circulation*



**FIGURE 3-5:** *Examples of large wood stabilization*

examples of exposed armouring integrated with water access, circulation, and elements of the public realm.

**Figure 3-5** provides examples of woody toe stabilization, providing habitat and armouring. **Figure 3-6** provides examples of a gravel bank river edge.

Although naturalization of the project is desired, some areas will require more manicured riverfront as well as public access. Those areas requiring public access will be hardscaped with cobbles, larger block stone, or other

hardscape to be determined in collaboration with recreational goals. Hardscape as well as naturalized water access options are identified in this report. Where large armouring is required it is recommended that a separation layer be included beneath the armouring, on top of the existing fill or native materials that will be exposed in the cuts, to minimize the potential for migration of fine soil particles into voids in the armouring layer which could result in future ground loss and subsidence. This layer could consist of a geotextile separator fabric, or a properly graded soil filter.



**FIGURE 3-6:** *Examples of gravel bank*

Further field investigation and analysis is required to address the following design elements:

- Analog sand bed channel morphology  
- Analog sand bed channels nearby will be evaluated to determine free formed , channel slope, channel width, bank slopes, bank vegetation, natural channel levee development and overbank vegetation along similar zones of channel influenced by lake backwater as the Don River project reach
- Sediment transport – Analog channels

nearby will also be evaluated for the nature of sediment transport, sediment gradation, delta morphology and response to human disturbances

- Construction logistics – Analog channels will be evaluated for bank and floodplain stratigraphy, soil content and stability. This information will relate directly to constructability of banks and wetland features given the available soils
- In-river habitat – Nearby analogs will be examined for habitat forming elements such

as large wood, channel bedforms, scour, undercut banks, and spawning habitat maintenance

- Critical habitat areas – Identify sensitive and ecologically critical areas within the project area for isolation during construction and long-term preservation

Given the potential for contaminated subgrade soils, and the need to protect the project from scour and erosion, it may be prudent to build the proposed channel in three layers, with distinct substrate gradations serving different functions. **(See Appendix A)** The substrate sizing computations will be completed for the next design iteration based on the geomorphology and hydraulics of the proposed system. The constructed channel layers are outlined conceptually as follows:

1. Subgrade or Grade control base (bottom layer, GCB) - This is the immobile layer below the channel bed that limits the depth of scour and separates the constructed channel and wetland soils from subgrade soils. A clay or geosynthetic liner may be required to provide this separation, this will be confirmed in future design work. Estimated required substrate size varies from 300mm to cobbles, and probably gravel for the much of the channel. It is anticipated that the nominal diameter for armouring in critical areas may be on the order of 500mm to 750mm. The armour layer thickness should be taken as a minimum of two times the nominal diameter of the largest armouring particles for preliminary estimating purposes. The final gradation may include a fine fraction to prevent leaching of any suspected contamination from underneath the GCB, as determined by other consultant partners. This may need to span the entire floodplain bottom in areas where long term channel migration is allowed. The channel and

wetlands will sit on top of the GCB.

Estimated thickness is approximately two feet and will be verified during the next design phase. Depending on the shear analysis, it may only be necessary to build the cobble “pad” at the two bridge crossings and eliminate any other rock needed in between.

2. Channel bed (middle layer) - The constructed bed thickness for channels of this size is usually around the 0.3 – 0.5 m range. The required thickness of this layer in combination with the subgrade layer may also be influenced by considerations coming out of the risk assessment process, such as the potential depth of bioturbation or benthic burrowing, if the channel bed is required to provide physical separation from impacted soils below. The bed will likely be a gravel and coarse sand mixture for most of the reach. In the bridge constriction areas, the bed will be a thinner cobble and gravel mixture on top of the grade control base. We may propose use of scattered boulders where velocities are expected to keep the channel scoured. The channel bed layer will also need to span the entire floodplain bottom in areas where long term channel migration is allowed. This is the layer upon which the channel meanders. Sediment moving through the channel will create bed heterogeneity on top of this layer, within the channel boundaries defined by the banks.
3. Banks and floodplain (top layer) - This will be a layer of imported soils, consisting of a mixture of sand, clay and loam, placed on top of the grade control base and channel bed layers. The relative percentage of these components will depend on expected groundwater elevations and vegetation planned. This is the layer through which the channel may adjust over time. The core structure of

the levee will be tested in following design phases to ensure the design provides for stable berms and river banks, with limited river movement allowed where appropriate.

See **Appendix B** for description of typical sections and Design Concept details.

### 3.1.4 ICE MANAGEMENT

There are generally two locations that will require careful design to mitigate detrimental ice impacts to the naturalized system. First, the confluence of the Keating Channel and the Don River is identified as an Ice Management area. The design team will collect local information during subsequent design phases to evaluate the following information required to establish a design basis:

- What is the historic range of elevations for ice flows? How does Toronto propose to actively manage ice in this area?
- What type of large wood is available? What is its strength, diameter and rot speed before it is no longer useful? What type of woody vegetation takes its place when this occurs?
- Will the ice forces directed on the wood be large enough to splinter it? Based on the size, wood strength and orientation, will the system mitigate these forces?
- If not, how do we mitigate risk behind the wood if it fails or do we utilize a harder rock-based system?

The second location identified as potentially requiring ice management, are the riverine wetland areas. TRCA has mentioned a concern that the wetland areas would be susceptible to having freshets in the spring, which raise the frozen ice surface and “pluck” the vegetation from the wetlands. This issue will require further evaluation once ice impacts on similar wetland areas are evaluated.

## 3.2 FLOW CONTROL WEIR

The weir system to control the flow split between the Keating Channel and the naturalized channel of the Don River is a critical part of this project, and will have significant impacts on the flood conveyance of the river system, as well as the ecological systems in the naturalized channel. The adaptive weir system near the Lake Shore Bridge is a mixed fixed weir / adjustable weir system which will allow for some control of the flow split between the naturalized channel and the Keating Channel. Preliminary design activities conducted as part of the EA were focused on hydraulic conveyance, with a primary objective being the passage of the regulatory event. See Figure 6-2 within the 2014 DMNP EAR for location of weir at Don River Reaches 1 and 2. Figure 6-5 within the 2014 DMNP EAR exhibits the location of the Upstream Weir and Sideflow Weir at the Don River. No significant changes to the location and performance of these weirs have occurred since the 2014 ESR document, however the formal configuration and adjustable mechanism has been considered during the Due Diligence phase of work for operational requirements, and will be further studied in the future schematic design phase of work.

While the conveyance of the regulatory event remains a primary objective, a set of further objectives to be considered for refinement of the weir system design can be stated as follows:

- Below the 2-year event flow, the predominant flow should be into the naturalized channel of the Don River, with some allowance for diversion to the Keating Channel to allow for flushing to improve water quality
- The upstream adjustable weir must default to the down (fully open) position during large flow events, including the regulatory event.
- The adjustable weir needs to allow for flexibility in the flow split during smaller

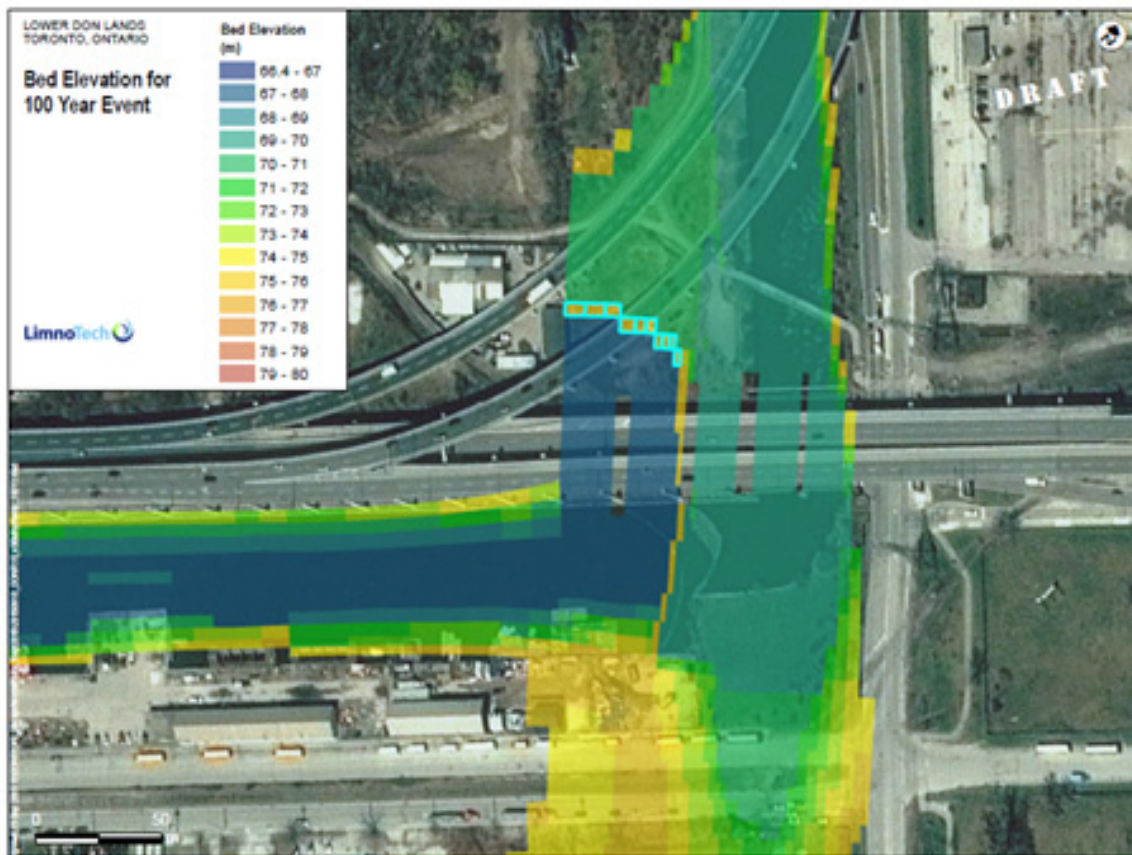

**FIGURE 3-7:** EFDC model representation of weir system

storm events.

- The adjustable weir should be operated by automated controls which can be remotely accessed, but which do not compromise its fail-safe design.

Previous evaluations of the weir configuration were conducted using an EFDC model developed in parallel with TRCA's Delft model. The EFDC model's representation of the weir system is presented in **Figure 3-7**. Physical modelling will be required in future design phases to confirm the design of the weir structure.

It is anticipated that the depth to bedrock below the base of the proposed weirs will be on the order of about 4 m to 6 m. Although the resulting contact stress from the weir structures on the foundation soils is expected to be relatively low, supporting the weirs on

shallow foundations is not recommended for the following reasons:

- Presence of variable thickness, composition and compressibility of foundation soils may result in differential settlements along the length of the proposed weir structures;
- Potential for scour and undermining of shallow foundations due to high flow velocities during extreme flood events could result in differential settlements of the weir structures; and
- Potential for unbalanced lateral forces due to different water levels on opposite sides of the weirs during extreme flood events could result in lateral movement (sliding) of the weir structures.

Each and any of the above could result in unacceptable vertical and/or horizontal movement(s) which could impede operation of



**FIGURE 3-8:** Example of inflatable adjustable weir

the inflatable weir and/or cracking of the static weir. As such, it is recommended that the weir structures be supported on pile foundations (driven steel H-piles, driven pipe piles or caissons) founded on bedrock.

### **3.2.1 ADJUSTABLE UPSTREAM WEIR**

The preliminary adjustable weir design calls for an inflatable dam with a bottom hinged steel plate along the upstream edge, similar to the example shown in **Figure 3-8**. The adjustable weir will be constructed of multiple segments placed in a single straight line between west bank of the Don River and the second pier of the Lake Shore Bridge.

The current orientation of the adjustable weir is at a 30° angle from the upstream face of the Lake Shore Bridge. The current orientation results in a total weir length of approximately 54 meters. This orientation will also require the construction of approximately 27 meters of dock wall along the western bank to protect against wall scour. The current maximum height

of the adjustable weir is 4.25 meters from the bottom of the channel.

The orientation and maximum required height of the adjustable weir will be refined during later design phases. The goal of the adjustable weir is to minimize its impact on the flow when it is in the fully open position. The orientation and length of the inflatable dam may be reduced based on the extent of its impact.

The preliminary design also calls for the addition of turning vanes upstream of the adjustable weir to direct regulatory event flows towards the western two bays of the Lake Shore Bridge. This structure is not represented in the current model and will need to be evaluated as part of future design efforts.

During final design of the adjustable weir, special care will need to be taken when designing the gate controller program. The weir will need to automatically increase flow to the Keating Channel in a response appropriate to the level of threat to the surrounding

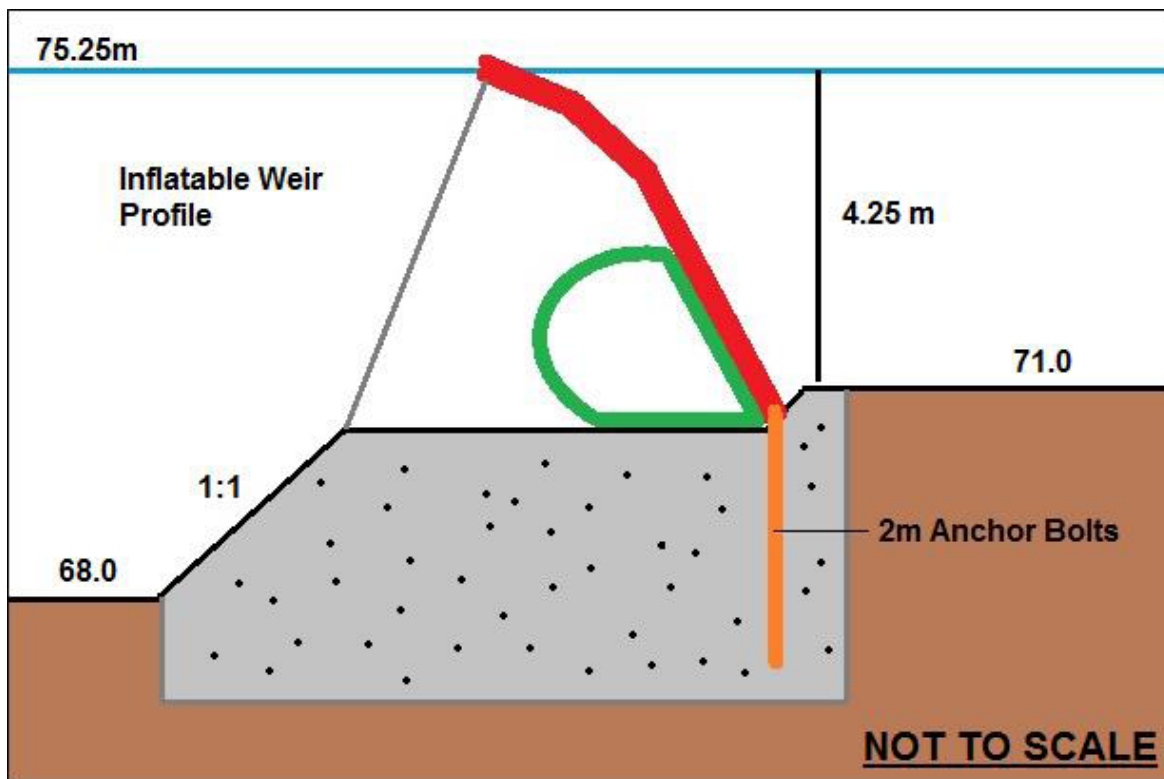

**FIGURE 3-9:** Proposed inflatable weir profile

infrastructure. This will require integration of the weir controllers with upstream level sensors on bridge crossings and at gaging stations. The controllers will also need to be designed in such a way that the gates will default to the open position in the event of a system fault (e.g. electrical, mechanical, or communication failure).

Finally, a boom system or buoy rope line should be installed across the downstream opening of the bridge piers to deter public access to the downstream edge of the adjustable weir.

The inflatable dam design described above is a preferred starting point for further evaluation, but other design alternatives that should be considered include:

- Hydraulic actuators in lieu of inflatable cells.
- Omission of the upstream steel plate.
- Multiple turning vanes
- Ice control and winter operations of the

inflatable weir system

Based on the preferred use of an inflatable dam, the preliminary design for the weir system has been informed by early discussions with Obermeyer Hydro, a leading provider of such systems. Based on the proposed 4.25m tall gate, the following recommendations were provided:

- a weight of 4100 lbs/ linear metre (not including any foundation structure below the gate)
- 2 m long anchor bolts to hold the gate in place
- anchor bolts could either be secured into bedrock (if present at shallow depth near the elevation of the proposed base of gate (71.0 masl)), or alternatively would have to be embedded within a minimum 2.0 m thick concrete foundation/spillway (as shown in **Figure 3-9**)



Obermeyer raised a concern about the placement of the gate in a high tailwater area. Based on the information shown on the Due Diligence report drawings (MVVA, 2015), the median lake level in Lake Ontario is at approximately Elevation 74.7 masl, and may increase during storm events. Obermeyer noted that in the case of high tailwater (about 3.7 m of pressure head on the base of the gate for tailwater at median lake level), the water pressure exerts force on the inflatable bags that may cause pinching resulting in problems with the bag deflation, which in turn means operators may not have the ability to open the gate quickly or fully during high flow events. Mitigation strategies, including an additional vacuum system or manifold system offering multiple air outlets, will be studied in future design phases to ensure the system is designed to 'fail open' as desired.

### **3.2.2 SIDEFLOW WEIR**

The preliminary design calls for a fixed weir downstream of the Lake Shore Bridge. This weir is a side spilling weir which extends nearly parallel with the naturalized channel flows. The current design calls for a straight weir 75 m long with a crest elevation of 75.25 m.

The weir will be constructed with one or several notches to allow for a minimum water quality discharge to the Keating Channel at all times. The notches will also serve as a means to skim some of the surface detritus off of the flows to the naturalized channel of the Don River. The discharge to the Keating Channel will be controlled in part by the operation of the upstream adjustable weir and in part by lake elevations.

The specific configuration of notches in this weir will be considered in future design phases in order to allow for a determined volume of water to pass into the Keating Channel during baseflow conditions. This notch is currently located 5 meters from the downstream end of

the weir in order to maximize capture of surface detritus. Future design efforts will be required to determine the optimal size, location, and elevation of the notches.

During the schematic design phase, design detail alternatives should be considered that include improvements to either accommodate pedestrian access to the pier structure (e.g. elevated walkway above the pier with appropriate handrails) or to exclude pedestrians from the structure (e.g. beveled edges and fences/gates to prevent pedestrians on weir). If the static weir will be used for access, the structure width will need to be sized accordingly.

### **3.2.3 SYSTEM ADAPTABILITY**

The success of the weir in meeting the design objectives will be in part dependent on lake level elevations that influence the flow split at the weir location. In particular, managing a flow split that prioritizes flow to the naturalized channel of the Don River under smaller events but progressively delivers more of the peak flow to the Keating Channel under larger events will likely require adjustment to the notch elevation of the fixed weir and adjustment of the adjustable weir elevation control system. Both of these design elements may require revising in response to changing Lake Ontario water levels due to climate change, or downstream lock and dam operations, or to changes in the discharge hydrograph of the lower Don River in response to further urbanization, or to positive changes in hydrologic management practices upstream.

The optimal flow split objectives will continue to be developed in the following schematic design phase of work, along with selection of specific weir designs.

### 3.3 SPILLWAY

The spillway/greenway connects the naturalized channel with the Ship Channel to the south, functioning primarily as a naturalized area, but providing additional conveyance capacity during large flood events, as noted in section 6.1.1.1 of the 2014 DMNP EAR. No significant changes have been made to the strategy for the spillway and its design objectives, listed below:

- provide lake connected wetlands hydraulically connected to the Ship Channel
- include control structures to protect against invasive species migration
- constructed levee to separate naturalized channel and spillway to be to overtop when flood events reach the 25 to 50 year flood elevations
- armouring design to stabilize levee and allow for vegetation where possible
- adequate armouring along valley walls of spillway and connection to Ship Channel

The design team has determined, in collaboration with Waterfront Toronto as well as Toronto and Region Conservation Authority (TRCA), that to optimize the performance of the wetland systems adjacent to the constructed naturalized channel of the Don River, water level controls need to be installed on the downstream end of the wetland systems. The constructed wetland system located on the spillway between the naturalized channel and the Ship Channel will also have a control structure between the wetland and the Ship Channel to allow for active control of the water level in the wetland system, (see Section 3.4).

The results of LimnoTech's preliminary modelling (see Appendix A), suggest peak flow velocities of between 0.5 m/s and 1.0 m/s over the spillway in the 1 in 100 year return period flow event and peak flow velocities of between 4.0 m/s and 5.0 m/s during the regulatory event. These velocities have been

verified through preliminary calculations by Golder Associates. For flow velocities in the 5 to 6 m/s range, the typical recommended rip rap sizes are on the order of 300 mm (for channel bottom) and 1200 mm (for 2H:1V bank slopes).

### 3.4 WETLAND CONTROL STRUCTURE

The proposed control structures will need to be tied into the levees that contain the wetlands, and have internally adjustable weirs to change the water level. This will allow for the water level in the wetlands to be actively controlled to optimize the ecological performance of the wetland, allowing them to be filled, retain water, or be drained throughout the year without being directly connected to the lake and river system water levels. These structures will need to have exclusion screens or other means of keeping carp from entering the wetland systems.

Figure 6-20 in section 6.1.3.3 of the 2014 DMNP EAR illustrates a concept for an active control structure. The functionality of these structures has had no significant changes since the 2014 DMNP EAR, however, the design and location of these structures within the Spillway and riverine wetlands will be developed in detail in the upcoming schematic design phase of work. The design objectives for these structures are listed below:

- provide control and limit access for invasive species
- allow for access of native and desirable species
- allow for adaptive operation to monitor and control specific conditions
- integrate the structures within stabilized banks to provide an aesthetically considered design solution that will contribute to both the public's experience and hydraulic control

### **3.5 SEDIMENT AND DEBRIS MANAGEMENT**

The sediment and debris management area is required to maintain safe navigation and flood protection through the river channel. Design of the sediment and debris management area is outlined in Section 6.1.2 of the 2014 DMNP EAR. No significant changes have been made since this report. Detail design of the management area and selection of specific operational design will be refined as part of schematic and detail design, through on-site testing of various operational systems and refinement of spatial design requirements.

Refer to section 6.1.2.1 of the 2014 DMNP EAR for a description of the sediment and debris trap, dredging frequency, and hydraulic dredges. Figure 6-12 within the 2014 DMNP EAR exhibits Sediment and Sebris Management Layout.

Two options are currently being considered for the location of the hydrocyclone and dewatering operations. The two options offer different opportunities for efficiency of sediment transport off-site, as well as spatial and environmental implications for design of the public parkland realm. Both options require different operational infrastructure, as noted in section 6.1.2.2 of the 2014 DMNP EAR. Refer to this section for a description of the sediment conveyance system. Figure 6-15 within the 2014 DMNP EAR exhibits Approach to Sediment Management (Option A), Figure 6-16 within the 2014 DMNP EAR exhibits Approach to Sediment Management (Option B). Selection of the sediment conveyance system and hydrocyclone location will be determined in detail design work. Dependent on the selected management system, a new dredge, dewatering system, and low-head tug boat may need to be purchased.

Refer to Section 6.1.2.4 of the 2014 DMNP

EAR for a description of equipment and spatial requirements of the Sediment and Debris Management Area.

### **3.6 DON ROADWAY VALLEY WALL FEATURE**

A Valley Wall Feature (VWF) is required along the Don Roadway to eliminate the risk of flooding to lands east of the Project Study Area. Refer to Section 6.1.1.1 of the 2014 DMNP EAR for a description of the VWF proposed along the Don Roadway from Lake Shore Boulevard to the Ship Channel. Figure 6-6 within the 2014 DMNP EAR exhibits general dimensions of the Valley Wall Feature South of Lake Shore Boulevard.

### **3.7 EASTERN AVENUE FLOOD PROTECTION**

Grade modifications are required surrounding the Eastern Avenue underpass of the CN Rail line to protect against minor flooding during the Regulatory Event. Further information for this grade modification is provided in TRCA's flood protection narrative. Design of this area will be further refined in detail design work. Refer to Section 6.1.1.1 and Section 6.6.2.7 in the 2014 DMNP EAR for description of flood protection.

### **3.8 FIRST GULF FLOOD PROTECTION LANDFORM**

A Flood Protection Landform (FPL) will be located on the east bank of the Don River between the CN Rail bridge and the Keating Yard to permanently eliminate the risk of flooding on the First Gulf Site (21 Don Roadway). The design and requirements of this FPL are described in Section 6.1.1.1 of the 2014 DMNP EAR, and illustrated in Figure 6-4 of that section. No significant changes have been made to this landform and flood protection strategy since the 2014 DMNP EAR.



# 4 PUBLIC REALM AND PARKLAND FOR RECREATIONAL USE

The first three sections within this chapter address the quality and character of the Lower Don River parklands and floodplain through a description of the proposed program, topography and vegetation developed by MVVA. These sections describe each topic at a conceptual level, and have been developed with respect to the guidelines provided in the 2014 DMNP EAR and 2014 LDL EAMP Addendum & ESR. The fourth section of this chapter describes consideration of planting soils across the site, reflective of the design developments presented in the first three sections. The fifth section of this chapter addresses considerations of maintenance needed for parklands, describing development since the 2014 ESR.

## 4.1 PROGRAM AND CIRCULATION

This section describes design developments related to park programming, and contains no significant changes to the guidelines set in section 6.2.4 of the 2014 EAR.

In addition to 29 hectares of naturalized area, the conceptual design identifies over 16 hectares of parkland above top of bank outside of the new river valley system that is intended to accommodate passive and active recreational uses. This parkland includes the park at Promontory Park, Villiers Park, and

North and South River Park. Park programming may include sports fields, event spaces, lawns, playgrounds, public gardens and other park program and service components as may be appropriate. The programming of these parks has been considered conceptually during the Due Diligence phase of work.

Park programming for the Lower Don River has been studied to determine the capacity of the site to hold various programs, and the appropriate scale of potential programmatic elements. After considering the surrounding network of city parks and the future context of adjacent development, thematic zones of program have been proposed for the Lower Don River site, as shown in **Figure 4-1**.

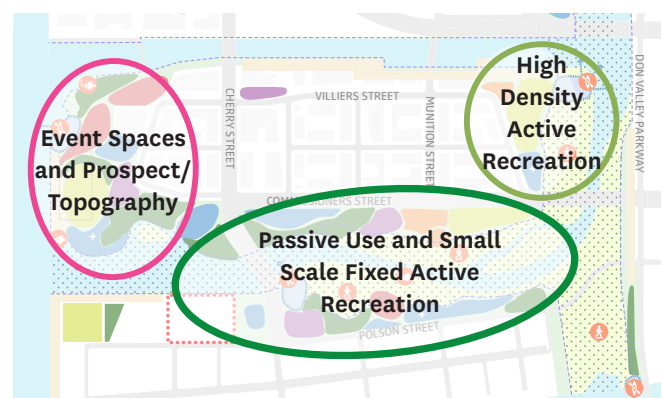

**FIGURE 4-1:** Park Program Concept Diagram



**FIGURE 4-2** Full Vision Floodplain and Park Program Plan

**Legend**

- |  |                         |  |                     |  |                               |  |                   |
|--|-------------------------|--|---------------------|--|-------------------------------|--|-------------------|
|  | River Valley + Wetlands |  | Esplanade           |  | Other Parkland                |  | Trail             |
|  | Wooded Upland           |  | Playground          |  | Floodplain                    |  | Small Boat Launch |
|  | Passive Use Lawn        |  | Public Gardens      |  | Private Land                  |  | Fishing Area      |
|  | Active Recreation       |  | Event Space         |  | Regulatory Flood Event Extent |  |                   |
|  | Water Access            |  | Prospect / Overlook |  |                               |  |                   |



**FIGURE 4-3:** Scale and Capacity Program Study

**Figure 4-2** illustrates a breakdown of proposed programmatic zones into appropriate program types, such as active and passive recreation, public gardens, and playgrounds. The distribution of these program types reflects access, views from the islands, proposed topography and distribution of activity across the site. As the public realm and parkland components of the design are primarily located outside of the naturalized areas and floodplain, there are minimal technical issues or constraints, although some consideration of settlement mitigation measures will be required following the grade raise in many of the park programming areas. Within the floodplain, in the area noted as *River Valley*, passive program use such as trails, boardwalks, overlooks, and

fishing sites will be provided. These features must be developed using appropriate materials and construction techniques in order to minimize effects on water quality. In addition, they must be developed to ensure the safety of park users and the sustainability of the vegetation communities. There will be no active recreational facilities, nor will there be high mast lights and ancillary features (such as parking), within the floodplain.

A scale study of program elements presents potential programs and distribution as a way of analyzing site capacity, as shown in **Figure 4-3**. This study determined that the site is well suited for carrying small scale fixed program, or flexible use larger program areas. The scale of area available above the floodplain is not

adequate for large sports fields such as full size soccer or lacrosse field, however, it is sufficient to accommodate a youth soccer field, or multi-use field of similar size in a few locations. The Due Diligence phase has considered a range of program types requiring varying degrees of maintenance and operational oversight. For example, the passive use lawn would require minimal oversight, whereas a winter ice skating ribbon would require significant operational oversight and supporting storage and maintenance facilities.

A selection of program elements, and specific layout will be determined during the future schematic design phase of work through consultation with the City of Toronto Parks Department to determine appropriate uses and operations allowances. Programming of the park spaces will also continue to be coordinated with concurrent precinct planning processes,

including the Villiers Island Precinct Plan.

A conceptual trail system has been proposed for the primary trail system within the new river valley floodplain adjacent to the low flow channel. It will be a major connecting link between the Don Valley trail system, the Don Greenway and the Martin Goodman Trail, as well as the various natural communities in the Lower Don Lands, providing a “green” gateway to the Port Lands. The main linkages are illustrated conceptually on **Figure 4-4** and are subject to change. The main trail is intended to be a multi-use trail for pedestrians and bicyclists, and will likely not extend below the 25 year flood line to avoid active flooding areas and minimize damages and maintenance costs for the trail. Where crossings of more flood prone or sensitive areas must occur, this may take advantage of raised trails and boardwalk strategies to provide the protection

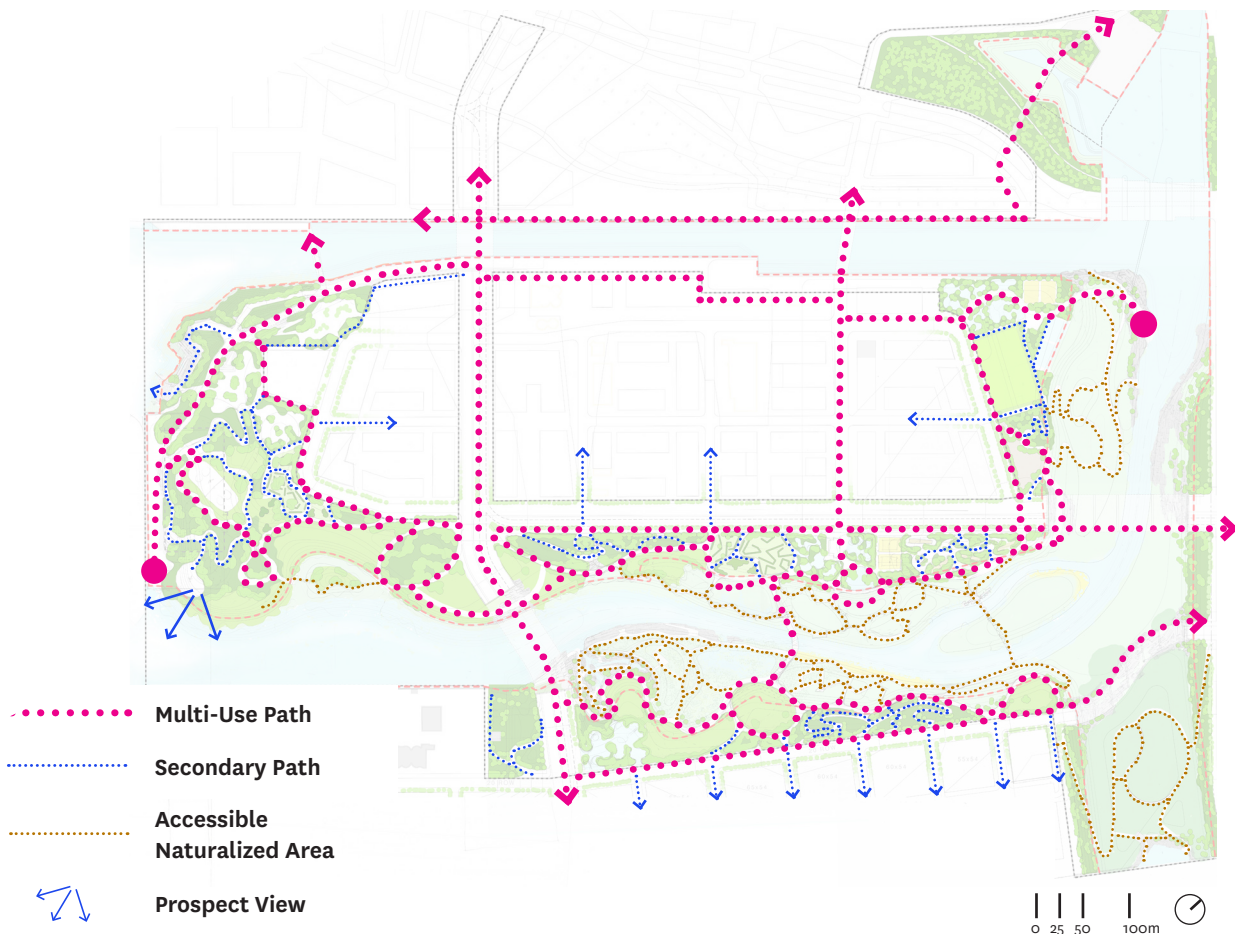
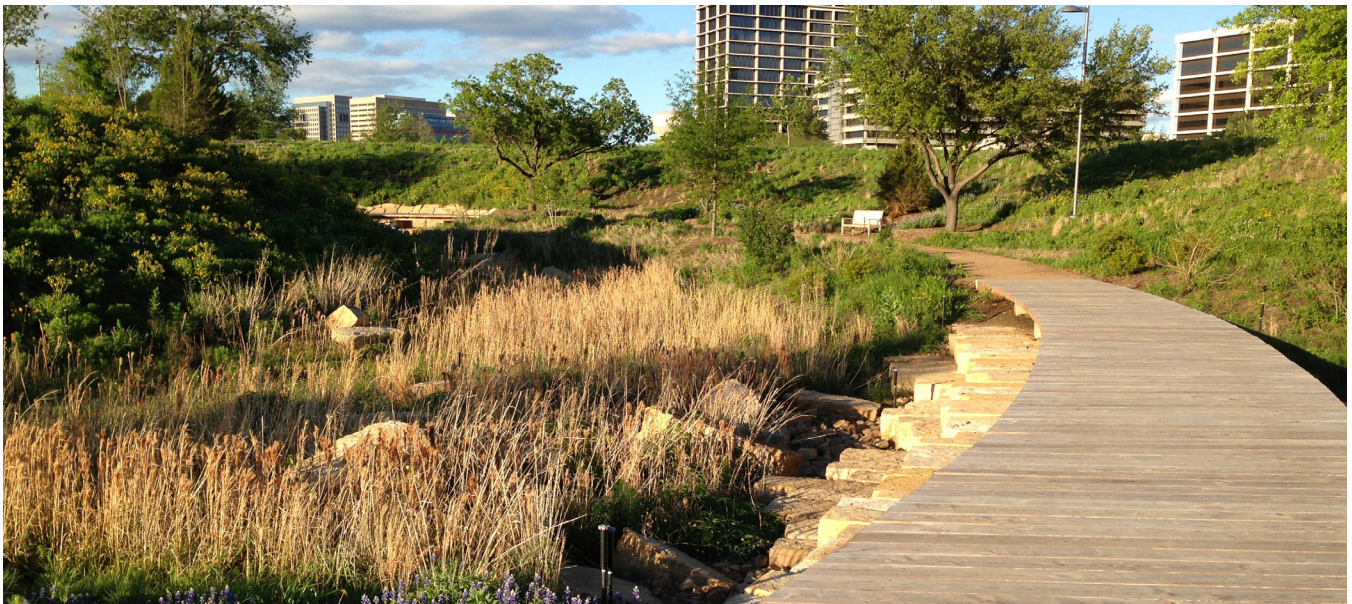

**FIGURE 4-4:** Valley and Park Circulation





**FIGURE 4-5:** Example of boardwalk crossing at wetland and river channel



**FIGURE 4-6:** Example of short span boardwalk crossing at wetlands

needed. **Figure 4-5** and **Figure 4-6** illustrate examples of boardwalk crossings, showing quality of material and construction intended for these elements. Long span boardwalk crossings will provide pedestrian access across portions of the wetlands and river channel, while short span boardwalk crossings will provide a low crossing for pedestrians at small wetland areas. Additionally, a multi-use crossing may be provided over the river

channel for both pedestrians and bicyclists, linking into the multi-use trail on either side. The design of all wetland and river crossings will be tested and verified through flood modelling in the following design phase. Access to the river for recreational boating will also be provided. **Figure 4-7** illustrates an example of an armoured boat launch, showing quality of material and construction intended for these elements. A comprehensive



**FIGURE 4-7:** Example of armoured boat launch

trail system including secondary and tertiary trails will be developed in the following schematic design phase of work to address needs for uninterrupted habitat areas, as well as adequate access and circulation for recreational uses.

#### **4.1.1 STREETScape**

We intend that the quality of material and site furnishings should match that of surrounding streets. We will hold the quality of Queens Quay as a starting point – stone sidewalks with concrete LRT rail, bituminous concrete roadway, and similar quality of site furnishings, lighting elements, and plantings.

Streets within the Villiers Island Precinct will be considered during a later phase, but will be of a similar quality, without provisions for LRT tracks, and more generous pedestrian and bike ways.

#### **4.2 TOPOGRAPHY**

Topography will be used on site to allow for variation in experience, program, and views. A conceptual idea of topography has been studied and proposed in the Due Diligence

phase of work. Topography will be further developed in the future schematic design phase of work in response to development of program, access, and volume of fill material predicted on site. A flexible approach for topography has been considered to allow for future adjustment depending on actual balance of cut and fill on site during construction operations. This approach will be further studied and assessed in future design phases.

#### **4.3 PLANTING**

This section describes design developments related to planting, and contains no significant changes to the guidelines set in section 5.1.2.2 and 6.2.4 of the 2014 EAR.

Approximately 32.7 hectares of naturalized area is proposed as part of the conceptual design and consists of the following habitat types, as identified during the previous EA process:

- 5.4 hectares of terrestrial habitat above the regulatory event extents
- 13 hectares of wetland habitat below the regulatory event line, however, it has been identified as part of the Due Diligence work that some of this area will need to be armoured to resist erosion
- 14.3 hectares of permanent aquatic habitat

The creation of new naturalized areas within the Lower Don River contributes positively to achieving the objectives of the Toronto Remedial Action Plan (RAP) for improving ecosystem health and rehabilitating fish and wildlife habitat (TRCA, 2009d). The habitat types that will be created are comprised of the vegetation communities identified in Section 5.1.2.2 of the 2014 EA Report Chapter 5, which include:

- Upland forest and / or thicket
- Treed swamp
- Thicket swamp

- Meadow marsh
- Emergent marsh
- Submergent marsh

Additional planting will be carried through the parkland area, in some areas limited with more hard surface and paving, whereas other program areas such as public gardens will contribute significant planted area to the overall site surface.

In the Keating Channel, the placement of stone revetments will act to stabilize existing dockwalls and simultaneously provide structure for fish habitat. This concept has had no significant changes since the 2014 EAR. See Figure 6-8 in section 6.1.1.1 of the 2014 DMNP EAR for further description.

#### **4.3.1 PARK PLANTING STRATEGY**

Planting within the park upland will be designed to provide comfortable, safe, beautiful spaces for proposed use and program. Selection of species will consider native and adapted species, as well as appropriate planting for proposed use, and the creation of varied and differentiated spaces within the Lower Don River. Planting will respond to topography, and reflect any determined microclimates produced by topography or planned future development. Planting will range from lawn to upland forest and garden, and will contribute to the terrestrial habitat provided within the Lower Don River site.

#### **4.3.2 FLOODPLAIN PLANTING STRATEGY**

Planting within the floodplain will be designed to create functional wetlands within the riverine system while accommodating flood conveyance for a regulatory storm event. The design team continues to assess the viability of deformable or migrating river banks through segments of the project, but intends to collaboratively work with TRCA to accommodate fish exclusion and

adjustable weirs, which inherently require fixed levee locations. The planting strategy in this zone will consider the dynamic nature of wetlands due to varying lake levels and occurrence of storm events. The floodplain will also be considered to provide comfortable, safe, and pleasing spaces for public access and use. The wetland and associated riverine levee configurations will be designed to accommodate riparian tree plantings, which will provide long-term habitat complexity and diversity. Selection of species will consider native and adapted species, as well as appropriate planting for flexible establishment of the wetland system, and the creation of varied and differentiated habitats within the Lower Don River floodplain. Planting will respond to topography, and reflect any determined microclimates produced by topography or planned future development.

#### **4.3.2.1 Aquatic Habitat and Site Ecology**

One of the goals of the project is to establish habitat to support game fish including walleye and northern pike, and other native species including bowfin. Ongoing fish survey work by TRCA will be used to evaluate the priority of habitat creation for a range of native fish species. River bottoms will be designed to mimic analog river mouths and will ideally include diversity of depth in various locations. Deeper pools will be designed on the outside of meander bends where larger scale deepwater habitat can be maintained through scour, and around large wood installations where smaller, local scour pools can be maintained. Shallower areas will be designed on the inside of meander bends and in straight run sections. Various large wood habitat locations will be designed for a range of lake levels over all four seasons. The intent of the design is to provide a broad range of habitat that will accommodate changes in lake levels due to climate and lake outlet management changes. The location of the large wood structures as well as the bank

design will accommodate recreational users and fish species at low flow, while also provide the robust design needed to remain secure in higher flow events. See **Figure 4-8** for a typical detail of this type of bank system.

Impact of invasive species will be integrated into the design of the proposed wetlands and river system. In subsequent design phases, further discussions with TRCA and Waterfront Toronto are needed to identify if any measures should be taken to control or prevent invasive plant species within the project area. As the natural outlet for a drainage area already impacted by invasive species, there is a steady source of invasive seeds into the project. Wetland water management with the proposed weirs may allow TRCA to limit invasive impacts in some wetland cells as well as prevent carp impacts to the emergent vegetation in those protected areas.

### 4.3.3 PLANTING SOILS

Soils with horticultural properties are required

to support the planting proposed for the parkland and naturalized landscapes. The existing on-site soils are currently being evaluated for contaminants, and it is assumed at this time that none of the existing material will be re-used as planting soil. All planting soil shall be manufactured (blended) off site and imported to the site.

Though there are a variety of plant communities proposed, they can be generalized into three planting soil profile depths. See **Figure 4-9** for a conceptual strategy for planting soils across the site, denoting the following soil depths:

- Tree Planting Soil - Depth 1.2M
- Shrub, Marsh, Levee and Wetland Planting Soil - Depth 750mm
- Lawn Planting Soil - Depth 500mm

It is assumed the planting soil is environmentally clean and is considered acceptable material for a 1.5M cap required as a barrier to existing soils within the project area.

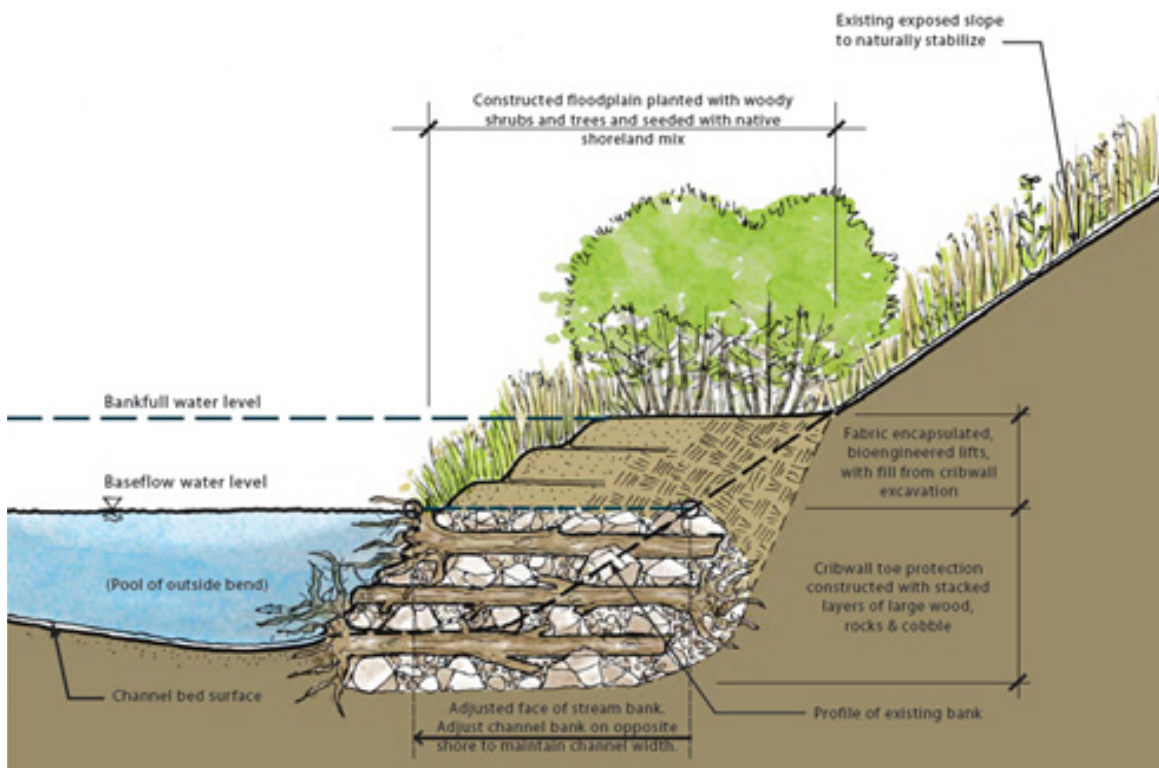

**FIGURE 4-8:** Example of large wood stabilization

## Planting Soil Volumes

### Legend

- Tree Planting Soil  
Depth - 1.2m
- Shrub, Marsh, Levee & Wetland  
Planting Soil  
Depth - 750mm
- Lawn Planting Soil  
Depth - 500mm



**FIGURE 4-9:** Plan Diagram of Planting Soils

Where the planting soil is shallower than 1.5M, ordinary fill will comprise the difference. Refer to the Earthworks/Environmental Engineering report for indication of required cap depth.

The planting soil will be designed to support the specific proposed plant community and landscape use. Each planting soil type is created by blending the soil components at various ratios to control nutrient levels and water retention. The components consist of the following materials:

- Base Loam
- Sand
- Organic Matter (Compost, Pine Fines)

Laboratory analysis will be required to ensure horticultural quality control for blended soil's mechanical, chemical and organic composition and for its hydraulic conductivity. The components shall be initially tested for

compliance prior to being used in the blends. Once approved, these components will be blended at the determined ratios to create the specified planting soil. Once in production, every 1,500m<sup>3</sup> of material will be tested.

It is assumed that as part of the RA/RM for this site, additional laboratory analysis will be required for the these imported manufactured planting soils for environmental compliance. Refer to the Earthworks/Environmental Engineering report for testing protocol and rates.

In planting areas where slopes are 3:1 or steeper, soil stabilization is required. The planting soil will be blended with polyurethane fibers (geo-fibers) at a rate of 4.15kg/m<sup>3</sup>. Geo-grid may be required to stabilize the subgrades. Bio-degradable erosion control matting will be used in the naturalized areas to prevent planting soil erosion and support plant establishment.

Within the areas indicated as Tree Planting Soil in **Figure 4-10**, the promenade and public realm areas will have structural planting soil under pavements.

The subgrade material is currently being characterized for its drainage properties, but it is assumed the material is inconsistent and will not infiltrate. To prevent saturated planting soil and resultant anaerobic conditions that lead to plant decline and death, there will be an underdrainage system. The subsurface water will be collected in a continuous sand blanket layer at the interface of the planting soil and subgrade and directed through a network of perforated PVC pipes. The intent is to re-use this water, but the application and infrastructure has yet to be determined.

#### 4.4 MAINTENANCE

No significant changes to the maintenance strategy and scope for the floodplain have occurred since 2014. Refer to section 6.4 of the 2014 EAR for a description of this scope.

Per feedback received during the Due Diligence phase of work, the City of Toronto Parks, Forestry and Recreation Department has identified the need for an operations building and yard space to accommodate the operational needs on the new park located above the floodplain and nearby parks. This scope had not been considered previously and will require further development in subsequent design phases. The operations facility may include all or some of the elements listed below:

- A yard to accommodate approximately 20 staff for the Lower Don River and neighbouring parklands
- Secured yard space to accommodate vehicles and machinery, including: approximately 5 pick-up trucks, 3-4 cutting machines, a small loader, and 3-4 utility vehicles (golf carts)

- Medium sized storage space for hand tools and small machinery
- Space for material storage, including gravel, compost, and other loose items
- Operations building including an office, washrooms, lunchroom, and lockers for 20 staff
- Additional 20 paid parking spaces for staff and visitors

The parkland areas will require ongoing maintenance activities associated with a number of the design components. These include maintenance of program elements such as sports field and courts, operational requirements of elements such as an ice ribbon, and maintenance of vegetation within naturalized terrestrial and park areas. Specific maintenance requirements will be determined in the future schematic design through consultation with the City of Toronto Parks, Forestry and Recreation, and may include activities listed below:

- Removal of invasive and undesirable plant species from planted areas, as deemed necessary
- Maintenance of site furnishings, including light features, fences, and benches
- Maintenance of services including public restrooms and drinking fountains
- Removal of debris and waste within park areas and waste receptacles
- Discouragement of nuisance wildlife from naturalized areas
- Maintenance of site surfaces, including pavement and athletic surfaces
- Regular inspection of barrier to site soils to ensure that the integrity and thickness is maintained







# 5 EARTHWORK

The following sections describe an assessment of environmental conditions, any significant changes to Soil Management Practices, Management of Contaminated Soils, Cut and Fill and Phasing within the Lower Don Lands study area since the 2010 LDL ESR, 2014 LDL EAMP Addendum & ESR, and 2014 DMNP EAR were released.

## 5.1 PRELIMINARY ASSESSMENT OF ENVIRONMENTAL CONDITIONS

### 5.1.1 EXISTING CONDITIONS

The lands in which the project is to undergo construction were formed largely through the reclamation of historical marsh lands and estuarine areas during the 1800s and early to mid-1900s through the infilling of Ashbridges Bay between the historical Don River mouth and Fisherman's Island to the south. A range of materials, including dredge spoils, soils from other borrow sites, foundry sands and construction debris were used in this reclamation. These fill materials are heterogeneous in nature across the project area. In many locations non-soil materials including debris, ash, coal, concrete, wood, brick, and asphalt are present within the fill materials. The materials used in the reclamation of these lands are of an environmental quality that does not meet current Ministry of the Environment Site Condition Standards.

Native soils underlying the fill materials generally consist of layers of sand and silt and extensive areas of peat, organic clays and other compressible soils.

Subsequent to the infilling of these lands,

they were subjected to a number of industrial and commercial uses that have contributed a range of contaminants to soil and groundwater within the study area. Previous investigations have identified the presence of a range of contaminants including petroleum hydrocarbons (PHCs), polycyclic aromatic hydrocarbons (PAHs), polychlorinated biphenyls (PCBs), chlorinated solvents and metals and inorganic parameters.

### 5.1.2 GENERAL PRINCIPLES

It is anticipated that the environmental management of the project area will be conducted under a combination of a Community-Based Risk Assessment (CBRA) process in consultation with the Ontario Ministry of the Environment and Climate Change (MOECC), and site-specific risk assessment (RA) processes that may be conducted under Ontario Regulation 153/04 to permit the filing of Records of Site Condition (RSCs) that may be required to support changes in land use from former commercial and industrial uses to more sensitive land uses such as residential and parkland uses. The CBRA and/or site specific RAs are anticipated to define requirements for environmental risk management measures that will need to be incorporated into future construction within the project lands. Although these specific requirements have not yet been defined, it is anticipated that they will fall into the following general categories of requirements:

- Physical barriers to existing soils within the project area, which are intended to limit the potential for future contact between existing soils that do not meet current Site Condition

Standards and future human receptors (e.g. park users, outdoor workers, residents or City of Toronto maintenance workers) or ecological receptors (e.g. plants or wildlife) that may otherwise have the potential come into contact with these soils;

- Physical barriers to limit the potential for migration of impacted groundwater or non-aqueous phase liquids (NAPL) into the future river channel; and
- Barriers to limit the potential for intrusion of contaminant vapours (particularly associated with petroleum hydrocarbon or solvent impacts) into buildings or other enclosed occupied spaces (e.g. commercial or residential buildings, or in the context of the public realm or parklands, enclosed park pavilions, maintenance facilities or similar structures).

### **5.1.3 ANTICIPATED REQUIREMENTS AND PARALLELS TO OTHER DESIGNATED WATERFRONT AREA DEVELOPMENTS**

For preliminary design and budgetary planning purposes, it may be assumed that the risk management requirements applicable to future construction may be similar to the requirements that have been implemented in other Waterfront Toronto developments in the Designated Waterfront Area, particularly in the East Bayfront and West Don Lands, which have a number of parallels to the current project area, including:

- The presence of heterogeneous fill materials of an environmental quality that does not meet current Site Condition Standards;
- The presence of similar contaminants in proximity to surface water bodies including the Don River and the Toronto Inner Harbour (i.e. Lake Ontario);
- The localized occurrence of non-aqueous phase liquids, as is the case with portions of

the East Bayfront Lands; and

- Similar post-development land uses, including parklands as well as mixed residential and commercial developments.

Specific considerations for the three categories of risk management measures described above are presented below.

#### **5.1.3.1 Barriers to Existing Site Soils**

Based on City of Toronto requirements that have applied elsewhere within the Designated Waterfront Area, it is anticipated that the following requirements will apply to the construction of physical barriers to existing soils within the project area:

- The full land area represented by parklands and municipal roadways may need to be underlain by a minimum thickness of 1500 mm of materials that may include:
  1. Hardscape, such as asphalt, concrete, or unit pavers;
  2. Aggregates sourced from a commercial facility; or
  3. Soils meeting applicable Site Condition Standards as listed in the Soil, Ground Water and Sediment Standards for Use under Part XV.1 of the Environmental Protection Act, anticipated at this time to be a combination of the Table 3 or Table 9 Site Condition Standards. In some cases, property-specific fill cap standards have been developed and accepted by MOECC in place of the use of the generic Site Condition Standards.
- Barriers to existing soils are anticipated to be incorporated around utilities that are to be constructed within the roadways. Where these barriers have been constructed elsewhere within the Designated Waterfront Area, they generally consist of commercially supplied aggregates, or of earth fill materials that meet applicable Site

Condition Standards. Typical thicknesses of these materials that have been required for environmental barrier purposes elsewhere in the Designated Waterfront Area are 0.5 metres underlying the deepest utility, and 1.0 metres laterally from the sides of each utility.

It is noted that an August 27, 2015 memorandum from Arup USA Inc. (Arup) suggests the installation of certain of the future utilities within utilidors. The use of utilidors could be an alternative risk management approach to the construction of earth fill or aggregate barriers to site soils, but is not recommended. Utilidors were deemed cost prohibitive from a utility installation perspective and micro-tunneling or other trenchless installation methods has been identified as the recommended approach.

#### **5.1.3.2 Barriers to Limit Migration of Contaminants into the River Channel**

It is anticipated that a barrier between the new river channel and the surrounding site soils will be required to provide two functions:

- Provide physical separation of ecological receptors, such as benthic (i.e. bottom-dwelling) aquatic organisms from impacted soils and groundwater; and
- Provide a physical barrier that would limit the inflow of contaminated groundwater (or NAPL, if present) into surface water at rates that could impair water quality and present an unacceptable risk of impacts to ecological aquatic receptors or humans.

The first of the two functions listed above is anticipated to be provided by aggregate layers (e.g. sand bedding, armour stone, etc.) that would be required for the hydrological design of the river channel. These materials, on their own, would not be expected to sufficiently limit the inflow of contaminated groundwater or NAPL into the river channel. It is anticipated

that a separate low-permeability liner may need to be incorporated into the river channel design to limit the degree of groundwater/surface water interaction. The nature of this liner would depend in part on the construction method that is to be employed for the river channel. If excavation of the channel is to be undertaken in “dry” (dewatered) conditions, then a liner made of compacted clay, geomembrane or similar low-permeability material could be constructed prior to inundation of the river channel. If excavation of the river channel is to be undertaken through dredging, options for the construction of the liner may be limited. Certain geomembrane liner materials, such as PVC, may be deployed and welded underwater prior to the placement of aggregate and/or armouring layers over the river channel. Sub-aqueous capping using materials that are capable of sufficiently attenuating the flow of impacted groundwater (e.g. clay or concrete), or that are reactive to the contaminants of concern (e.g. granular activated carbon or zero-valent iron), may also be possible. As an alternative, vertical groundwater cut-off walls may be installed at the crest of the new river channel or at an appropriate location along the new channel side slopes in sensitive areas or where the nature of the contamination suggests higher potential for impacts to groundwater. Although information is still pending from the investigation program being undertaken by GHD Limited (GHD), particular areas where groundwater-surface water interactions may require additional mitigation may be the areas of boreholes MW28-15 and MW33-15 along the north side of the proposed river channel. Both of these areas have been identified by GHD as having the potential for the occurrence of both light and dense NAPLs in close proximity to the proposed channel.

#### **5.1.3.3 Barriers to Limit Migration of Vapours into Enclosed Spaces**

The investigation results reported to date

by GHD and in previous investigations have identified the occurrence of peat layers in the subsurface soils, which occur at thicknesses of up to several metres within the project area. The presence of buried peat layers is associated with the potential for the generation of methane gas, which has been identified during subsurface investigation programs elsewhere within the Designated Waterfront Area. The investigation results provided by GHD to date have not reported on concentrations of methane, but based on the stratigraphy reported by GHD and in previous investigations, methane occurrence can be expected in subsurface soils above the water table.

Certain of the contaminants reported to be present in subsurface soils or groundwater within the project area, particularly solvents and PHCs in the gasoline and diesel ranges, may be associated with the potential for the generation of vapours in unsaturated soils above the water table. The data reported by GHD to date indicate significantly elevated organic vapour concentrations of up to 2000 ppm in shallow fill materials that have indications of PHC impacts, such as odours and staining. In addition to these reported headspace concentrations, the nature and extent of impacts reported in historical investigations (particularly areas where NAPL has been reported) suggest that the generation of contaminant vapours is possible.

The possible presence of methane and of contaminant vapours in soil generally does not present a significant concern for outdoor areas, as contaminants generally dissipate readily through effects of wind or other atmospheric transport mechanisms. They do present a concern, however, where an enclosed structure is to be constructed in areas where contaminant vapours or methane may be present. In these cases, systems to mitigate the intrusion of vapours may be required. Elsewhere in the Designated Waterfront Area, these systems have generally included the

following elements:

- Where the foundations of enclosed structures extend below the water table, these foundations have typically included a spray-applied or geomembrane vapour barrier as part of the foundation design, with the specific material being selected based on considerations of vapour permeability and resistance to degradation by the contaminants of concern.
- Where foundations are constructed above the water table (e.g. slab-on-grade construction), vapour mitigation systems have incorporated the following components:
  1. A spray-applied or geomembrane vapour barrier as described in item (1) above; and
  2. A sub-slab vapour mitigation system that provides a pathway for the dissipation of contaminant vapours or methane gas that may be present beneath the foundation. Typically, systems that have been used within the Designated Waterfront Area have incorporated passive ventilation of areas under foundations to outdoor air, with provisions for retrofit of these systems to allow for active ventilation if vapour intrusion is noted.

It should be noted that these requirements for vapour mitigation have typically not applied to sub-grade structures that are not regularly occupied, such as stormwater tanks, maintenance holes, or similar structures that may only be accessed on an intermittent frequency.

## **5.2 PRELIMINARY GEOTECHNICAL ASSESSMENT**

This section provides a preliminary summary of the anticipated geotechnical requirements that may need to be incorporated into the conceptual and preliminary design and current cost estimating exercise for the Don Mouth

Naturalization and Lower Don Lands Flood Protection Project. This section has been arranged around the elements outlined in **Table 5.2-1** below; a brief summary of key

considerations from a geotechnical perspective is provided in **Table 5.2-1**, and further discussion regarding each of these items is provided in the following sub-sections.

**TABLE 5.2-1:** Summary of Preliminary Geotechnical Considerations and Requirements by Project Element

Element	Brief Summary of Key Considerations	Additional Information and Work Required
Settlement due to grade raises – see Sections 5.2.2 and 5.2.3	Grade raises typically on the order of about 1 m to 3 m are required over the majority of the site, but fills on the order of about 8 m (and locally up to a thickness of about 15 m) are required at Essroc Quay. These grade raises/fills will result in time-dependent settlement of the compressible fill and native soil layers. Section 5.2.2 summarizes the anticipated magnitude and duration of settlement for each key area (the valley wall features, Promontory Park and Essroc Quay lakefill, roadways/utility corridors, and the future precincts), along with feasible settlement mitigation measures for each area.	<ul style="list-style-type: none"> <li>■ Completion of second phase of subsurface investigation and incorporation of all geotechnical investigation data into YPDT database to continue to refine the subsurface model and the conceptual/preliminary settlement estimate(s) for each area.</li> </ul>
Valley Wall Features – see Section 5.2.4	The Northeast and Southeast Valley Wall Features will be subject to settlement due to the grade raise in these areas. Additionally, these features will require a core of lower permeability material, which may require an off-site source if insufficient clayey soil is available from the proposed river channel excavation.	<ul style="list-style-type: none"> <li>■ Detailed design of the Valley Wall Feature core and shells to confirm the required material types and quantities.</li> <li>■ Assessment of mitigation measures for subsurface utilities that are proposed to cross through the valley wall features.</li> </ul>
Essroc Quay infill – see Section 5.2.5	The preliminary design and construction concepts presented by Riggs Engineering Ltd. (Riggs) in their “Essroc Quay Infill, Preliminary Design Update” dated September 1, 2015 are geotechnically feasible in terms of both the berm and structural wall confining features. Where new structural walls are required, they will likely need to be keyed into the shale bedrock for toe fixity, with lateral support provided near the top of the wall by tie-backs with rock anchors and/or deadman reaction systems.	<ul style="list-style-type: none"> <li>■ Confirmation of the thickness and composition of the lake bed soils is required as part of the next stage of design as the potential presence of thick, soft soils below the lakebed poses a risk to the constructability, stability and long-term performance of the infilling. This may be mitigated by dredging of the soft soils prior to construction of the confining berms/structural walls.</li> <li>■ More refined settlement and global stability analyses are recommended for the 8 m (average) and about 15 m (local) thick filling in this area, and preliminary assessment of reinforced slope design may be required for localized high fill feature.</li> </ul>

Element	Brief Summary of Key Considerations	Additional Information and Work Required
Structure foundations – see Section 5.2.6	<p>The site overburden soils are not suitable for support of new structures. The bridges will require deep foundations extending to bedrock, such as driven steel H-piles or pipe piles, or drilled steel casings or caissons. Downdrag loads should be considered for conceptual/preliminary design purposes.</p>	<ul style="list-style-type: none"> <li>■ Incorporation of additional geotechnical investigation data into YPDT subsurface model to refine the depth to bedrock for each bridge structure. Additional subsurface investigation at structure sites in future stages of design.</li> <li>■ Confirmation of requirements for pedestrian bridges crossing the new river channel.</li> </ul>
Keating Channel and existing/new dock walls – see Section 5.2.7	<p>Design of the grade raise adjacent to Keating Channel and dredging of the existing channel will have to take into account the effect of fill placement and dredging on the existing dock wall structures, where walls are required to remain in service in an interim or permanent condition. Where new channel/dock walls are required, they will likely need to be keyed into the shale bedrock for toe fixity, with lateral support provided near the top of the wall by tie-backs with rock anchors and/or deadman reaction systems.</p>	<ul style="list-style-type: none"> <li>■ Condition assessments to confirm integrity of existing channel walls and potential for continued use of and/or rehabilitation/revetment requirements in interim or permanent condition, versus requirement for new walls.</li> <li>■ Potential for deeper bedrock valley exists between Cherry Street and the existing Don River channel; further investigation will be required in later stages of design to inform the design of new channel walls in this area.</li> </ul>
Subsurface structures and utilities – see Section 5.2.8	<p>Key geotechnical issues for existing utilities that must remain in service in an interim or permanent condition will result from proposed grade raises, and the resulting settlement. Such settlement will also impact new utilities; differential settlement may occur along linear utility corridors as a result of variations in the thickness of underlying organic and/or compressible soil layers along the length of the corridor.</p> <p>Other key issues relate to the high groundwater table at the site. Dewatering will be required where open-cut utility excavations extend below the groundwater table (i.e., for trenches, or for deeper shafts for tunnelling operations). Buoyancy considerations may apply for some utilities or subsurface structures, which could include tie-downs anchored into the bedrock. For pumping stations and for shafts related to sewer or watermain tunnels extending under the river, it is anticipated that secant caisson walls may be required, extending to bedrock.</p>	<ul style="list-style-type: none"> <li>■ Comments regarding potential geotechnical issues and the need for settlement mitigation measures are of a general nature due to the limited borehole information available in the area of the road corridors, and limited available details regarding the proposed site servicing plan.</li> <li>■ As additional information becomes available, Golder can work with MVVA and MMM to further assess the geotechnical issues/constraints and refine the potential extent of required settlement mitigation measures along the new utility corridors, as well as to assess the impact of grade raises on key existing utilities that are required to remain in service on an interim or permanent basis.</li> </ul>

Element	Brief Summary of Key Considerations	Additional Information and Work Required
New river channel and spillway – see Section 5.2.9	Construction of the new river channel and spillway may be carried out using conventional excavation methods and equipment above the groundwater table. Below the groundwater table, dewatering to allow excavation in dry conditions is expected to be cost-prohibitive; dredging in wet conditions is anticipated to be more cost effective. However, consideration must be given to the requirement for and constructability of an environmental barrier. Conventional compacted clay or geosynthetic clay liners would require construction in dry (dewatered) conditions, whereas the use of vertical cut-off walls, some geosynthetic membranes, and/or subaqueous capping may be considered for wet conditions.	<ul style="list-style-type: none"> <li>■ Global stability analyses for the river channel slopes will be required when additional geotechnical data are available from boreholes within the proposed new river channel area, taking into account the presence of organic soils, soft/loose materials and the groundwater and surface water conditions.</li> <li>■ Additional assessment and development of the environmental barrier concept/ preliminary design will be required once all environmental and geotechnical data is available from the current investigation program.</li> </ul>

### 5.2.1 SUBSURFACE CONDITIONS – GEOTECHNICAL SETTING

The lands in which the project is to undergo construction were formed largely through the reclamation of historical marsh lands and estuarine areas during the 1800s and early to mid-1900s, through the infilling of Ashbridges Bay between the historical Don River mouth and Fisherman’s Island to the south. A range of materials, including dredge spoils, soils from other borrow sites, foundry sands and construction debris were used in this reclamation. These fill materials are heterogeneous in nature across the project area. In many locations, non-soil materials including debris, ash, coal, concrete, wood, brick, and asphalt are present within the fill materials. Native soils underlying the fill materials generally consist of layers of sand and silt and extensive areas of peat, organic clays and other compressible soils (e.g. soft clays), and loose silts. Bedrock is present at depths of typically 10 m to 20 m below the present ground surface.

The preliminary geotechnical assessment is based on limited geotechnical information obtained from the following sources:

- GHD Limited, 2015. Progress Update No. 1, Port Lands Environmental, Geotechnical and Hydrogeological Investigation, RFP #2015-23, Waterfront Toronto. August 17, 2015;
- GHD Limited, 2015. Progress Update No. 2, Port Lands Environmental, Geotechnical and Hydrogeological Investigation, RFP #2015-23, Waterfront Toronto. August 31, 2015;
- GHD Limited, 2015. Report No. 2, Port Lands Environmental, Geotechnical and Hydrogeological Investigation (Draft). September 15, 2015.
- Golder Associates Ltd., 2013. Geotechnical Site Investigation, Bayside Development Project, Queens Quay, Toronto, Ontario. Project No. 11-1152-0010. June 6, 2013 (Revised July 16, 2013). Report prepared for Waterfront Toronto;

- Alston Associates Inc., 2010. Geotechnical Investigation, Jarvis Slip to Parliament Slip, Toronto Harbour, Toronto, Ontario. Ref. No. 09-061. 15 March 2010. Report prepared for Halsall Associates Limited;
- Organic Layer Thickness Mapping provided by CH2MHill on September 4, 2015 (understood to be based on the Toronto Region and Conservation Authority (TRCA) York-Peel-Durham-Toronto (YPDT) database, and to represent the sum of “muck”, “peat” and “organic” layers as described in the TRCA database);
- Organic Layer Thickness (Figure 6), Preliminary Environmental Assessment and Geotechnical and Earthworks Report, Waterfront Toronto, Toronto, Ontario, dated September 30, 2015; and,
- Ministry of Northern Development, Mines and Forestry (MNDMF), Mines and Minerals Division, Ontario Geological Survey. Ontario Geotechnical Borehole Database. <http://www.mndm.gov.on.ca/en/mines-and-minerals/applications/ogsearch/geotechnical-boreholes> (September 15, 2015).

It is understood that additional information is currently being collected by GHD (i.e. additional boreholes, borehole elevations, geotechnical laboratory testing data, etc.). The preliminary comments should be reviewed when this additional information becomes available, including incorporation of the GHD investigation results into the YPDT database by CH2MHill to refine the subsurface model, and interpretation and mapping of the thickness of subsurface layers of organic materials and compressible clays.

### **5.2.2 SETTLEMENT DUE TO GRADE RAISES**

It is understood that the grades will be raised over the majority of the site (outside the

footprint of the new river channel) as part of the development of the Lower Don Lands. Based on the borehole information available to date, the subsurface conditions at the site include the presence of compressible soils (peat, organic silts and soft clays) that will be subject to consolidation settlement as a result of the proposed grade raises. Attachment C1 contained in **Appendix C** provides a summary of the available subsurface information, anticipated grade raises, preliminary magnitude of settlement and settlement rate (time) estimates, proposed settlement-sensitive structures located within the different grade raise areas, and potential settlement mitigation measures that are considered feasible for each of the proposed areas. Attachment C1 is broken down into the following proposed grade raise areas:

- Northeast Valley Wall Feature
- Southeast Valley Wall Feature
- Prospect/Promontory Park
- Essroc Quay Lakefill (within Promontory Park)
- Villiers Park
- Villiers Island (Precinct and Road Corridors)
- Ship Channel North (Precinct and Road Corridors)
- Sediment Management Area.

The Northeast and Southeast Valley Wall Features are separated by the Lakeshore Boulevard Corridor. It is understood that no significant grade raise is proposed along the current Lakeshore Boulevard Corridor. No borehole information is presently available at the Northeast Valley Wall Feature, nor is specific borehole information available for Villiers Island Precinct, Ship Channel North Precinct and the Sediment Management Area. Hence, only rough settlement estimates are provided for these areas based on the organic layer thickness



mapping provided by CH2MHill; the magnitude of settlement and appropriate settlement mitigation measures will need to be further assessed as and when additional borehole information becomes available.

### **5.2.3 SETTLEMENT MITIGATION MEASURES**

As noted in Section 5.2.2 and summarized in Attachment C1 in **Appendix C**, the loading from the grade raises (filling) required over the site will induce settlements of the underlying soils. Although the settlements from the silty sand and sand deposits will be relatively small and happen relatively quickly (i.e. during construction), the settlements from the organic silts, peats and clay deposits will be much larger and, given the nature of these materials, will occur over a longer time frame. In order to mitigate the risk of post-construction settlements occurring over the design life of the project, a variety of mitigation measures can be considered and carried out as part of the construction. A brief description of the mitigation alternatives and their applicability to various elements of the currently proposed development on this site is provided below.

#### **5.2.3.1 Preloading**

Preloading refers to placement of fill to the design grade raise elevation (in one or more stages), followed by a delay period (with monitoring) prior to constructing surface finishes, pavements and other features. The length of the delay period will be variable and depend on certain characteristics of the compressible soil layer(s) including, thickness, permeability and creep behaviour. In areas where the predicted time for settlement to occur is less than the length of the overall construction staging schedule and where the creep settlements are estimated to be relatively small, preloading could be considered as a settlement mitigation measure. Where these two criteria cannot be satisfied, a

more aggressive mitigation measure will be required. It is anticipated that preloading may be an option to mitigate settlements in Prospect / Promontory Park and Ship Channel North; however, certain settlement-sensitive features in these areas may require additional measures.

#### **5.2.3.2 Surcharging**

Surcharging is similar to preloading in that it involves placement of fill followed by a delay period (with monitoring) prior to construction of the surface features, however, with surcharging an additional thickness of fill (the surcharge) is placed over and above the design grade elevation. This additional lift of fill applies a greater load to and increases the stress in the foundation soils which increases the rate at which the settlement occurs. At the end of the surcharge period, the portion of the surcharge fill lift remaining above the design grade elevation is removed and the surface features constructed. In addition to reducing the time required to complete the settlement, the height and/or period of the surcharge can be designed to reduce the long-term, creep settlements that might otherwise occur. It is anticipated that surcharging may be an option to mitigate settlements in the Northeast and Southeast Valley Wall Features, Sediment Management Area, Villiers Park and along the Road Corridors (Villiers Island and Ship Channel North Precincts). However, completion of the borehole investigation is required in some of these areas to confirm the thickness of the compressible soils and further assess whether surcharging alone is viable to mitigate the settlements. In general, it is estimated that a minimum surcharge fill thickness of about 4 m (over and above the grade raise fill thickness) will be required to reduce the settlement time period to about one year (or less) and to minimize the post-construction creep settlements. It is noted that, depending on the phasing of the development, the surcharge fills

could be constructed in rolling stages that are re-used over different portions of the site.

### **5.2.3.3 Wick Drains (in Conjunction with Surcharging)**

Where the thickness of the compressible soil layer(s) is greater than about 4 m, the installation of wick drains into the foundation soils can significantly reduce the length of drainage path in the subsurface which controls the rate of excess pore pressure dissipation and therefore the rate at which the consolidation settlement occurs. Wick drains are prefabricated geotextile drains installed vertically from ground surface into and through the soft compressible foundation soils. Typically, wick drains are installed on a 1 m to 3 m spacing in a triangular grid pattern over the footprint of the fill / grade raise area. Upon completion of installation of the wick drains, the design grade raise fills plus a surcharge are constructed, followed by a delay period (with monitoring) prior to construction of the final surface features. It is anticipated that wick drains (installed at 1 m spacing) and surcharging (4 m thick) could be used in the Northeast Valley Wall Feature area to reduce the settlement time period to about one year (or less) and to minimize the post-construction creep settlements; however, completion of the borehole investigation is required in this area to confirm the thickness of the compressible soils. It is also possible that wick drains (in conjunction with surcharging) could be used along selected portions of the alignment(s) for the new utilities, where the thickness of compressible soils is greater than about 4 m, to reduce post-construction differential settlement of these features. The presence of obstructions within fill soils overlying the soft compressible layer(s) can impede the installation of the wick drains and could necessitate pre-drilling at some locations. The risk that such obstructions potentially pose, as well as the associated additional costs for drilling through these

obstructions, would have to be considered when selecting this alternative.

### **5.2.3.4 Sub-Excavation and Replacement**

In areas where the compressible foundation soils are very weak and/or where the required new fills are very thick, the complete sub-excavation of the weak layers and replacement with more competent fill soils is a viable alternative to maintaining stability of the fill mass as well as reducing settlement. In the area of the Essroc Quay Lakefill, it is noted that some of the borehole information indicates the potential for very soft clayey soils to be present below the lakebed. Given the requirements for large thicknesses of fill associated with construction of the in-water confinement structure(s) as well as the thickness of the in-water and above water fills, it is anticipated that sub-excavation (by dredging) and replacement of the clayey soils may be required in this area. However, boreholes will be required to be advanced in-water in this area to confirm and delineate the presence of weak soils.

### **5.2.3.5 Lightweight Fill**

Another alternative for reducing the magnitude of settlement and improving the stability in areas of weak/soft, compressible foundation soils is to use lightweight fill, such as blast furnace slag, cellular concrete or expanded polystyrene (EPS) as part of the required grade raise(s). An advantage of these types of fill materials is that their use can be designed such that little to no delay period is required after placement since the lightweight materials impose a much smaller increase in stress on the foundation soils (as compared with conventional fills). As a result, in many cases, the final construction can proceed shortly after placement. It is noted however, that some sub-excavation may be required in conjunction with the use of these materials to achieve a net zero-loading condition. These products can,

however, pose unique challenges to design and construction, including such factors as the following:

- Buoyancy (of cellular concrete and EPS) which can restrict their use to above water only;
- Environmental impacts (of blast furnace slag) from leaching of water through the fill mass which can restrict their use to non-in-water fill applications or areas where the fill can be encapsulated; and
- Cost (of cellular concrete and EPS) which can restrict their use to limited quantities in specific, critical areas.

Given the above, the widespread use of lightweight fill materials is not considered practical or cost-effective at this site. However, there may be certain limited areas where their use could offer some advantage (for example, in limited areas along roadways/utility corridors where localized poor soil conditions are present), but this may not be determinable until the detail design stage.

#### **5.2.3.6 Ground Improvement**

Ground improvement techniques such as aggregate piers or soil mixing could be considered to reduce settlements and improve stability in areas where compressible soils are present and/or where thick grade raises are required. These techniques are often expensive, but can be cost-competitive in situations where the alternative mitigation measure(s) may require the removal and disposal of contaminated soils or significant delay periods that affect the next phase of construction. An advantage of these types of mitigation measures is that in most cases, final construction can proceed shortly after completion of their construction. At present, there are no specific areas where ground improvement is considered to be required; however, it is possible that it could be an option

at critical portions of the alignment(s) for the new utilities or other specific structures, where either the compressible soils are thick or the structures are particularly sensitive to post-construction differential settlement.

It is noted that the presence of obstructions within fill soils overlying the soft compressible layer(s) can impede the construction of many of the ground improvement methods and could necessitate partial pre-excavation through the fills at some locations. The risk that such obstructions potentially pose, as well as the associated additional costs for drilling through these obstructions, would have to be evaluated when considering this alternative.

#### **5.2.3.7 Instrumentation and Monitoring**

An instrumentation and settlement monitoring program will be required following placement of fill materials to the design grade, and/or placement of surcharge materials above the design grade, in conjunction with any other settlement mitigation measures adopted for key areas of the site development. The instrumentation program is expected to consist of deep and shallow settlement monitoring points and vibrating wire piezometers installed at a sufficient frequency in critical, settlement-sensitive areas. These points would be surveyed and monitored at a regular frequency throughout the preloading/surcharging period, to monitor the magnitude and rate of settlement and confirm that the estimated settlements have been completed prior to construction of settlement-sensitive infrastructure or programming. This program will require further development in later stages of design.

#### **5.2.4 VALLEY WALL FEATURES**

From a geotechnical perspective, for conceptual design purposes and based on the currently available information and proposed grading,

it is recommended that a lower permeability core be incorporated into the valley wall features adjacent to the Don Roadway and the First Gulf site. This core would essentially be a zone near the western edge of the valley wall feature, comprised of clayey silt to silty clay material that is placed and compacted under controlled conditions to achieve a target minimum hydraulic conductivity. For the current conceptual stage, it may be assumed that the core zone has a minimum top width on the order of 5 m to 10 m, with the side slopes of the core sloped no steeper than 2 horizontal to 1 vertical (2H:1V). An appropriately graded outer shell surrounding the core will be required as well as armour protection on the river/spillway side of the core. Behind (to the east of) the core, there is no restriction on the permeability of the fill materials; it is recommended that fill materials in this area meet the requirements for select subgrade material, and be placed and compacted in accordance with engineered or controlled fill requirements, depending on any future programming.

The TRCA's guidelines suggest that the core of valley wall features will be subject to the same criteria as a flood protection landform. At this stage, it is recommended that the utility design/layout be completed with an aim to minimize the number/size of locations where utilities must breach the lower permeability core. However, the modes of failure associated with water flow through or under this type of landform are generally of lower risk than for a "narrower" flood protection landform. Therefore, it is anticipated that where utilities are required (for example, along the east-west road corridors), this risk can be mitigated. This would involve an assessment at the preliminary and detail design stages of the risks associated with flows along the utility corridors (including effects of the frequency and maximum amount of time that the water level will be above the toe of the landform, and the expected distance of penetration of floodwaters into the valley

wall feature). From this assessment, the core design can be optimized, and mitigation measures can be developed such as low permeability "water stops" (comprised of clay soil seals) and/or geosynthetic filter materials within the utility trenches at regular intervals.

### **5.2.5 ESSROC QUAY LAKEFILL**

Development of the Prospect/Promontory Park will require a significant volume of in-water lakefill in the northwest portion of the site, around the present-day Essroc Quay. Based on available information from a limited number of boreholes advanced in-water near this area (Alston, 2010), it is anticipated that the lake water is about 6 m to 7 m deep, and the lakebed/overburden may consist of up to about 5 m of very soft silty clay underlain by shale bedrock at a depth of about 12 m below lake surface. The thickness and composition of the lake bed soils in this area will require confirmation as part of the next stage of design, as the potential presence of thick and soft soils below the lakebed poses a risk to the constructability, stability and long-term performance of the structures proposed in this area.

The following sub-sections provide comments and preliminary geotechnical recommendations with regard to the construction concepts proposed by Riggs Engineering Ltd. (Riggs) as presented in their "Essroc Quay Infill, Preliminary Design Update" dated September 1, 2015. In general, the plan for the development in this area as proposed by MVVA and Riggs includes the construction of confinement structure(s), comprised of berms and structural walls to form a number of containment "cells" within which in-water filling can take place, followed by raising grades above the lake level to the design grade of the new park.

#### **5.2.5.1 Confinement Structure – Berm**

The Riggs concept currently indicates a zoned

berm structure comprising a triangular core, overlain by a 1 m thick layer of filter stone and a 1 m thick layer of rip-rap on the lake side, and overlain by a 0.5 m thick layer of clear stone and a geotextile layer on the in-water fill side. Preliminary geotechnical comments are summarized as follows:

- The core material should comprise 0.1 m to 0.3 m rock sizes.
- Filter stone (on the lake side) should comprise 0.3 m to 0.6 m rock sizes.
- Rip-rap (on the lake side) should comprise suitably sized armour stone material (as recommended by a coastal engineer) but may include up to 1 m or 1.5 m rock sizes.
- Clear stone (on the in-water fill side) should comprise 100 mm minus granular material with limited fines content.
- Geotextile should be selected considering the compatibility between the gradation of the clear stone and the gradation of the in-water backfill material(s).
- Construction of the in-water berm materials will likely result in placement with side slopes at about 2 horizontal to 1 vertical (2H:1V), but the fill slopes could possibly be cut back and steepened (up to about 1.5H:1V) after placement, if desired.
- As discussed in Section 5.2.2 and summarized in Attachment C1 in **Appendix C**, if soft clays are present in this area, it will likely be necessary to dredge all soft, organic, unsuitable material prior to fill placement and construction to mitigate potential instability and long-term, post-construction settlement

#### **5.2.5.2 Confinement Structure – Structural Wall**

In order to limit the extent of fill placement that may otherwise partially restrict the cross-section at the west end of the adjacent Keating

Channel, MVVA and Riggs are proposing to use a structural wall to provide confinement of the in-water fills on the north side of the Essroc Quay infill area.

Several types of structural walls are feasible for this new construction and a summary of the different wall options along with a discussion on the advantages and disadvantages associated with each (from a geotechnical perspective) is provided in **Table 5.2-3** in Section 5.2.7.

#### **5.2.5.3 In-Water Fill**

Following completion of construction of the confinement structures to form the “cells”, the placement of the in-water fills can be carried out. The following preliminary geotechnical comments are provided regarding the in-water filling:

- All organics and soft clay soils present on or below the lakebed should be removed prior to in-water fill placement; otherwise excessive settlement may occur.
- All in-water fills should consist of clean, granular materials (150 mm minus with limited fines content) placed in-water by end-dumping. Rock fill and clayey or organic fill are not recommended for in-water filling as post-construction settlements are more likely to occur.
- To reduce post-construction settlements of the in-water fills and mitigate against the potential for liquefaction, the in-water fills and granular lake bed sediments may require densification in-place by vibrocompaction following placement. The extent of the requirements for in-place densification will depend on the future land use overlying the in-water fill. In areas where settlement-sensitive structures or features will be constructed, in-place densification will likely be required; in other areas (i.e. open park space), post-construction settlements could be mitigated

by preloading and/or surcharging (as discussed in Section 5.2.3).

#### 5.2.5.4 Above-Water Fill

Following completion of the placement of in-water fills, the above-water fills can be constructed for Promontory Park. The following preliminary geotechnical comments are provided regarding the above-water fills:

- All above-water fills should be placed as engineered fill in controlled lift thicknesses (maximum 300 mm loose lift thickness). Where the fill is to support settlement-sensitive structures, such as concrete slabs, pavements and walkways, it should be uniformly compacted to at least 98% of the material's standard Proctor maximum dry density (SPMDD). Compaction of the fill to 95% of the SPMDD is sufficient where fill is placed in landscaped areas.
- Fill types should include granular or low-plasticity, fine-grained clayey silt material
- Organic soils, deleterious materials, and high plasticity clayey soils are not recommended for use as fills as these materials may result in excessive settlement
- Fill for the steep slope(s) of proposed promontory or prospect feature should comprise rock fill or granular fill engineered with geogrid reinforcement. Otherwise, these steep faces will be prone to erosion, over-steepening, ravelling, and post-construction instability
- The global stability of the proposed high fills in the promontory or prospect feature will need to be evaluated once additional information on the height, geometry and location is available.

#### 5.2.6 STRUCTURE FOUNDATIONS

The existing variable fill materials and native soils are not suitable for support of shallow

foundations for the proposed bridges. Deep foundations, extending to the bedrock surface, will be required. From a preliminary geotechnical perspective, the most cost-effective deep foundation solution is anticipated to be driven steel H-piles; however, driven pipe piles and caissons may also be considered as the design is refined. The following preliminary recommendations are provided for the purposes of refining costs at this stage, assuming HP310x110 steel piles driven to refusal on or in the shale bedrock; additional geotechnical investigation and analysis will be required at future stages of design to confirm and refine these recommendations:

- The number of piles for support of each bridge may be preliminarily assessed based on a factored axial geotechnical resistance at Ultimate Limit States (ULS) of 1,600 kN, and a geotechnical resistance at Serviceability Limit States (SLS, for 25 mm of settlement) of 1,400 kN
- At this conceptual stage, downdrag loads on pile foundations should be taken into account for all new structures. Assuming a grade raise on the order of 2 m or greater on the approaches to the bridge abutments, the downdrag load may be taken as 250 kN per pile for preliminary design purposes
- The approximate pile length may be determined based on the estimated bedrock surface elevations presented in **Table 5.2-2**; an approximate depth to bedrock has been estimated based on an assumed pile cap underside at Elevation 79 m (to be confirmed in later stages of design). These bedrock elevations have been interpreted from the closest available borehole data as contained in the GHD reports and the MNR database.

At this stage, augered, concrete-filled caissons are recommended as the foundations for the light poles, to provide sufficient lateral resistance. Geotechnical design will

**TABLE 5.2-2: Deep Foundations for Proposed Bridges - Preliminary Depth to Bedrock**

Structure	Approximate Distance to Nearest Borehole (m)	Approximate Bedrock Surface Elevation (m) <sup>1</sup>	Approximate Depth to Bedrock (m) <sup>2</sup>
Cherry Street Bridge over Keating Channel	<10	62.5	16.5
Munition Street Bridge over Keating Channel	<10	68	11
South Cherry Street Bridge (Polson Slip)	230	57	22
Commissioners Street Bridge over New River Channel	50	N/A <sup>3</sup>	18
Lakeshore Boulevard Bridge modifications (including rail line)	<10	69.5 – 71	6 – 18 <sup>2</sup>
Polson Street-Basin Street Bridge over Spillway	150	63	16
Trinity Pedestrian Bridge	50	66	13
Pedestrian Bridges over New River Channel	150 – 250	59.5 – 60.5	18.5 – 19.5

**NOTES:**

1. Approximate bedrock surface elevation from closest borehole, rounded to closest 0.5 m.
2. Approximate depth to bedrock based on assumed pile cap underside at Elevation 79 m, except for Lakeshore Boulevard bridge modifications where depth is given relative to ground surface at the time of the borehole investigation.
3. Ground surface elevation at borehole location not provided on borehole record.

be considered in future phases of work to determine the size required for these foundations.

### 5.2.7 KEATING CHANNEL AND EXISTING AND NEW DOCK WALLS

There is limited geotechnical information available in the area of Keating channel as a majority of the boreholes have not been completed yet; however, available historical subsurface information indicates that the overburden soils generally consist of non-cohesive deposits of sand and silt overlying shale bedrock at depths ranging from about 10 m to 13 m below the existing ground surface. At some borehole locations, a layer of clay up to about 2 m thick was encountered underlying the sand and silt deposits and overlying the shale bedrock. In an area to the west of the Don River channel between Don Roadway

and Munition Street, some of the historical boreholes encountered peat / organic layers up to about 5 thick.

Design of any grade raise adjacent to Keating Channel and dredging of the existing channel will have to take into account the effect of fill placement and dredging on the stability of the existing dock wall structures. It is understood that based on condition surveys by Waterfront Toronto, a majority of the dock walls within Keating Channel will require either replacement or stabilization using rock revetment on the in-water side to extend the service life of the walls. Where walls are required to remain in service in an interim or permanent condition (including walls being stabilized by revetment), a geotechnical and structural condition survey and assessment is recommended as part of preliminary design, including an assessment of the following:

- Effects of any proposed dredging in the Keating Channel on the existing wall stability;
- Effects of fill placement (behind and in front) on the existing wall stability, including impacts on any existing tie-backs/dead-man anchorages; and
- Structural capacity of existing walls to be raised where required to accommodate fill placement in an interim or permanent capacity.

Based on the results of the condition surveys, it may be possible to reuse some portions of the existing walls while replacing other components to extend the service life or increase the structural capacity of the dock walls.

New dock walls may be required where the existing dock walls are not capable of supporting the proposed fill placement and/or dredging, for placement of the proposed new lake fill at the west end of Keating Channel, and at selected other locations where no dock walls currently exist at Cousins Quay and Polson Quay. The new dock walls likely will need to be keyed into the shale bedrock which is anticipated based on current borehole

information to be at a depth of about 10 m to 13 m depth below existing ground surface. However, it is noted that the depth to bedrock may vary along Keating Channel, in particular in the area between Cherry Street and the existing Don River, where a deeper valley has been identified in the bedrock surface as part of geotechnical investigations north of Keating Channel.

Several types of retaining structures are considered to be feasible for new / replacement dock walls along Keating Channel. **Table 5.2-3**, provides a summary of the different wall options, along with a discussion from a geotechnical perspective on the advantages and disadvantages associated with each option. Consideration must be given to the potential presence of obstructions (cobbles/boulders, concrete rubble, existing cribbing or tie-backs, etc.) within the existing fill, and the potential impacts on construction methodology, costing and schedule when selecting the preferred wall type.



**TABLE 5.2-3: Summary of Feasible Channel Wall Types**

Wall Type	Advantages	Disadvantages
<p><b>Steel H-Pile and Pre-Cast Concrete Panel Wall</b></p> <p>Steel H-piles, driven or vibrated through the lakebed sediments and to refusal within the upper (weathered) portion of the shale bedrock, or socketed into bedrock, acting as soldier piles to support pre-cast concrete panels.</p>	<ul style="list-style-type: none"> <li>• High axial geotechnical resistance at ULS and geotechnical reaction at SLS for piles driven to, or socketed into, bedrock.</li> <li>• High lateral capacity for H-piles socketed into bedrock.</li> <li>• H-pile cross-section readily accommodates installation of concrete lagging panels.</li> </ul>	<ul style="list-style-type: none"> <li>• Dead-man anchor system likely required to provide additional lateral resistance for piles driven to bedrock.</li> <li>• Considering the variable composition of the overburden/sediments, it may be necessary to install some (or all) of the H-piles within pre-drilled, tremie concrete-filled sockets in the bedrock in order to provide adequate toe fixity at the base of the wall.</li> <li>• Some trenching/levelling within the overburden along the wall alignment would be necessary to ensure adequate sealing to minimize risk of potential loss of the backfill materials, which could lead to ground loss and settlement behind the wall.</li> </ul>
<p><b>Steel Sheet Pile Wall</b></p> <p>Steel sheet piles driven or vibrated through the channel/lakebed sediments and to refusal within the upper (weathered) portion of the shale bedrock.</p>	<ul style="list-style-type: none"> <li>• Conventional construction techniques.</li> <li>• Likely the most cost effective alternative.</li> </ul>	<ul style="list-style-type: none"> <li>• Relatively stiff sheet pile section may be required depending on height of wall.</li> <li>• Dead-man anchor system would likely be required to provide additional lateral resistance at the top of the wall.</li> <li>• Rock anchors (or toe pins) along some portions of the wall may also be required in order to provide adequate toe fixity at the base of the wall.</li> </ul>
<p><b>Steel ‘Combi-Wall’</b></p> <p>Steel piling wall made up of king-piles generally comprised of either steel H-piles or pipe piles with intermediate sheet piles (between the king-piles) functioning primarily as earth retention and load transfer to the adjacent king-piles.</p>	<ul style="list-style-type: none"> <li>• Strength and stiffness characteristics of the wall generally exceeds that available from traditional sheet pile sections.</li> <li>• High axial geotechnical resistance at ULS and geotechnical reaction at SLS for king-piles driven to or socketed into bedrock.</li> <li>• High lateral capacity for king-piles socketed into bedrock.</li> </ul>	<ul style="list-style-type: none"> <li>• Installation of king-piles must be carried out with great care and to a high degree of accuracy to ensure straight and vertical installation and correct spacing given the very tight tolerances associated with the connections.</li> <li>• Dead-man anchor system may be required to provide additional lateral resistance at the top of the wall at the highest wall sections.</li> <li>• Considering the variable composition of the overburden sediments, it may be necessary to install some (or all) of the H-piles within pre-drilled, tremie concrete filled, sockets in the bedrock in order to provide adequate toe fixity at the base of the wall</li> </ul>
<p><b>Cellular steel sheet pile wall</b></p> <p>Interconnecting circular steel sheet pile ‘cells’ backfilled with granular soil</p>	<ul style="list-style-type: none"> <li>• Similar construction techniques to steel sheet-pile wall.</li> <li>• Likely no requirements for a dead-man anchor system or rock anchors (or toe pins).</li> </ul>	<ul style="list-style-type: none"> <li>• Potential for difficulty in design and construction of seal between cells so as to avoid potential loss of backfill materials which could lead to ground loss and settlement behind the wall.</li> </ul>

## 5.2.8 SUBSURFACE STRUCTURES AND UTILITIES

The design and construction of utilities and subsurface structures will need to consider the presence of relatively poor subsurface conditions (as described in the above sections) and a high groundwater table. Preliminary geotechnical comments as they relate to the preliminary site servicing concepts prepared by MMM and Arup are provided in **Table 5.2-4** below. Comments regarding potential geotechnical issues and the need for settlement

mitigation measures are of a general nature due to the limited subsurface (borehole) information currently available in the area of the road corridors, and limited available details regarding the proposed site servicing plan. As additional information becomes available, Golder can work with MVVA and MMM to further assess the geotechnical issues/constraints and refine the potential extent of required settlement mitigation measures along the new utility corridors.

**TABLE 5.2-4:** *Subsurface Structures and Utilities - Preliminary Geotechnical Considerations*

Element	Preliminary Concept <sup>1</sup>	Preliminary Geotechnical Comments
New Utilities within Road Corridors	<ul style="list-style-type: none"> <li>■ Utilities to be installed in joint use utility trenches.</li> <li>■ Hydro, gas and communications to be installed within approximately 1.5 m by 1.5 m concrete-encased ducts, with 1 m to 2 m of cover.</li> <li>■ Watermains will be about 2 m deep; sewers will be about 3 m to 13 m deep.</li> <li>■ Installation of some future utilities within utilidors is being considered.</li> <li>■ Oil-grit separators (OGS) will be installed to pre-treat the stormwater on either side of the stormwater tunnel (see below) and will be approximately 3 m in diameter and 7 m deep.</li> </ul>	<ul style="list-style-type: none"> <li>■ No recent, detailed geotechnical subsurface information is currently available along the majority of the proposed road corridors. However, based on the borehole information available elsewhere on the site, variable fills and soft/compressible soils are anticipated. The anticipated average 2 m grade raise along the road corridors will cause settlement of the underlying compressible soils. Settlement mitigation measures will be required, which may include pre-loading/surcharging, wick drains, reinforced trench bedding (e.g. geosynthetic reinforcement), sub-excavation and replacement, lightweight trench backfill and/or ground improvement of the soils located below the new utility trenches (refer to Section 5.2.3).</li> <li>■ The groundwater table is anticipated to be relatively close to the existing ground surface at the site (i.e., close to lake level). Given the anticipated 2 m grade raise, the shallower utilities will likely be installed above the groundwater table; however, deeper utilities (e.g. deeper sewers and OGS) may be installed below the groundwater table and will require active construction dewatering (for example, well points and/or eductors).</li> </ul>
Ballasted Flocculation/UV Treatment Area	<ul style="list-style-type: none"> <li>■ At-grade structure located near the stormwater pumping station, with an approximately 10 m by 12 m footprint.</li> <li>■ Delivery truck and crane loadings.</li> </ul>	<ul style="list-style-type: none"> <li>■ The site soils are not anticipated to be suitable for shallow foundations to support of the at-grade structure.</li> <li>■ Ground improvement (refer to Section 5.2.3) or piles extending to the bedrock surface (refer to Section 5.2.6) will be required. There is potential for obstructions in the fill that could impact either ground improvement methods or pile installation, and further investigation is recommended as part of later stages of design to better quantify this risk and develop appropriate mitigation measures. The bedrock surface is at a depth of about 11 m at Borehole MW39-15, located in the vicinity of the proposed ballasted flocculation/UV treatment area.</li> </ul>

Element	Preliminary Concept <sup>1</sup>	Preliminary Geotechnical Comments
Pumping Stations	<ul style="list-style-type: none"> <li>■ Stormwater pumping station to be located on the south side of the Keating Channel, between the new river channel and New Munition Street, and is anticipated to be about 12 m in diameter and 12 m deep.</li> <li>■ Sewage pumping station to be located near the intersection of Don Roadway and Commissioners Street, and is anticipated to be about 3 m in diameter and 13 m deep.</li> </ul>	<ul style="list-style-type: none"> <li>■ Preliminary borehole information suggests that the invert of the stormwater pumping station will about 1 m to 2 m below the top of the shale bedrock surface. Bedrock excavation will be required. Shale bedrock is anticipated to provide suitable bearing conditions.</li> <li>■ Preliminary borehole information suggests that the invert of the sanitary pumping station will about 2 m to 3 m above the top of the shale bedrock surface. Over-excavation to bedrock will likely be required to provide suitable bearing conditions.</li> <li>■ Given the high groundwater table, it is anticipated that the deep shaft excavations will require the construction of secant caisson walls drilled into bedrock for the construction of the pumping stations. The secant caisson walls may form part of the permanent shaft walls. There is potential for obstructions in the fill that could impact the caisson wall installation. Further investigation will be required.</li> <li>■ Due to the high groundwater table, buoyancy forces will act at the base of the pumping stations. Tie-downs anchored into bedrock may be required.</li> </ul>
Tunnelled River Crossing(s)	<ul style="list-style-type: none"> <li>■ Storm sewer tunnel (1050 mm diameter) under the new river channel</li> <li>■ Watermain crossing (400 mm diameter) under the new river channel.</li> </ul>	<ul style="list-style-type: none"> <li>■ Will need to maintain sufficient cover below the river/channel bed.</li> <li>■ Horizontal Directional Drilling (HDD) may be considered for smaller diameter tunnels (e.g. watermains) within the overburden. Should the crossings be within bedrock (shale bedrock encountered at depths ranging between about 11 m and 19 m below existing ground surface), micro-tunnelling will likely be required.</li> <li>■ Larger diameter tunnels (e.g. sanitary sewers) will likely require micro-tunnelling. Micro-tunnelling shafts will likely need to be constructed using secant caisson walls given the high groundwater table at the site. The proposed storm sewer crossing is at about Elevation 68 m to 69 m. Boreholes in this area (MW18-15, BH76-15, BH79-15, BH84-15) have been terminated at about Elevation 70 m within wet, loose sand. These conditions (running sand conditions), if extending to the tunnel elevation, will require careful tunnelling procedures to prevent loss of ground during tunnelling. The currently proposed tunnel elevation provides limited cover of about 3 m between the invert of the tunnel and the bottom of the new river channel, which will also require careful procedures and controls; it is recommended that consideration be given to deepening the sewer below the river channel to improve the cover depth.</li> <li>■ There is potential for obstructions to be encountered in the site soils that could impact tunnelling operations. Further investigation will be required along tunnelling areas in future stages of design.</li> </ul>

Element	Preliminary Concept <sup>1</sup>	Preliminary Geotechnical Comments
Existing Utilities	<ul style="list-style-type: none"> <li>■ Certain existing utilities will remain in an interim/ temporary condition to service heritage buildings.</li> </ul>	<ul style="list-style-type: none"> <li>■ As described in Section 5.2.2, the grade raises will induce settlement of the site soils. Where existing utilities need to be maintained in service along the existing Villiers Street, Cherry Street and Polson Street in an interim capacity, the utilities will need to be protected in areas where organic or soft compressible soils are present. This protection could incorporate a piled grade beam to bridge over the existing utilities, for example.</li> <li>■ The utilities that will remain in place on an interim basis must be assessed in future design stages relative to the presence of organic/compressible soils based on their construction and condition details, their settlement tolerance, construction sequencing, etc. Further investigation will likely be required in future stages of design to confirm the thickness and geotechnical properties of compressible layers in key utility areas.</li> </ul>

**NOTES:**

1. Based on information provided by MMM (email dated September 4, 2015), Arup USA Inc. (Site Servicing Memo dated August 27, 2015), and MVVA (Due Diligence and Validation Report – 2015/09/15 DRAFT)

**5.2.9 NEW RIVER CHANNEL AND SPILLWAY**

Construction of the new river channel and spillway will require excavation and/or dredging of the existing soils; construction of an environmental barrier to prevent migration of contaminants in the site soils and groundwater into the river channel and to provide a physical separation of ecological receptors from impacted soils and groundwater; and stabilization and protection of the river channel banks following excavation and dredging.

**5.2.9.1 Excavation/Dredging**

From a preliminary geotechnical perspective, it is anticipated that excavation of the existing soils may be completed using conventional methods and equipment above the groundwater table (which may be assumed to be approximately at the lake level for estimating purposes).

For the scale of the proposed work below the groundwater table at this site, it is considered that dewatering to complete the excavation and

construction of the new river channel “in the dry”, while technically feasible, would require an extensive cut-off wall and pumping system, together with treatment of the pumped water to remove entrained sediment and improve the environmental quality of the water prior to discharge. Such an approach is anticipated to be cost-prohibitive, although it may merit further consideration if a cut-off wall system is adopted as a permanent environmental barrier. From a geotechnical perspective, it is anticipated that excavation of the existing site materials below the water table will be more cost effective using dredging techniques.

To refine the conceptual design and costs at this stage, the design and construction of the new river channel should take into account the following preliminary geometric considerations:

- Side slopes (river banks) would likely fall or run to approximately 3 horizontal to 1 vertical (3H:1V) to 5H:1V below the water during excavation and if left “untreated”; however, the below-water slopes could be graded as steep as approximately 2H:1V if provided with appropriate armouring

/ surface erosion / scour protection immediately after final grading

- However, from a global stability perspective, considering the presence of organic materials and soft/loose fill and native soils, plus the potential for rapid drawdown conditions over a portion of the river bank during flood recession, side slopes below the design flood level are preliminarily recommended to be formed no steeper than 3H:1V
- It may be feasible to incorporate ground improvement/stabilization techniques in the river bank area prior to dredging, to minimize the potential for over-excavation and flatter side slopes (i.e., to reduce the over-excavation volume between 2H:1V or 3H:1V and 5H:1V). This will require further assessment during subsequent stages of design
- Global stability analyses will be required when additional borehole information and geotechnical test results are available from boreholes within the proposed new river channel area, taking into account the presence of organic soils, soft/loose materials and the groundwater and surface water conditions

#### **5.2.9.2 Geotechnical Aspects of Environmental Barrier**

As a preliminary geotechnical concept, the environmental barrier along the new river channel and spillway could consist of a compacted clay liner or geosynthetic clay liner. Both of these options are typically constructed in “dry”, dewatered conditions in order to allow appropriate placement and compaction of the clay layers to form the barrier. However, as noted above, construction of the new river channel in dewatered conditions is anticipated to be cost-prohibitive, and so these types of environmental barriers may not be best-suited for this project.

The following alternatives may be considered to minimize or eliminate the requirement for dewatering to place conventional clay liners along the new river channel and spillway:

- Vertical groundwater cut-off walls (comprising steel sheet piling with grouted joints) installed at the crest of the new river channel or at an appropriate location along the new channel side slopes in sensitive areas, or where the nature of any contaminants suggests higher potential for impacts to the groundwater and the river. Such walls would likely have to extend to the shale bedrock (typically 10 to 20 metres below ground surface), although further assessment and conceptual/preliminary design is required once all of the current investigation data is available
- A geomembrane liner that is deployed and welded underwater, following grading of the dredged slopes and prior to the placement of aggregate and armouring layers over the river channel
- Sub-aqueous capping using materials that are capable of sufficiently attenuating the flow of impacted groundwater (clay and/or concrete), or that are reactive to the contaminants of concern (e.g. granular activated carbon that could sorb organic contaminants, or zero-valent iron that may react with chlorinated contaminants)

#### **5.2.9.3 Surficial Protection**

Surficial protection of the new river channel and spillway side slopes will be required to prevent erosion / scour and could consist of one of, or a combination of, the following:

- Appropriate vegetation
- Armour stone / rip-rap
- Concrete facing; and/or
- Traditional channel / wall construction

As noted in previous sections of this report, soft/loose and organic soils are present throughout the site, and any “structural” protection measures that are to be supported on the soil, such as gabion baskets or toe walls, will require assessment based on available geotechnical data specific to the location of such proposed measures. There are likely to be limits to the height of such wall features from the perspective of global stability and geotechnical resistance/settlement performance.

Where larger armouring is required (Armoured Edge, Buried Armour Profile and Grade Control Structures), as well as the Woody Toe Protection (in which logs/trees are embedded with rock/cobble layers), it is recommended that a separation/filter layer be included beneath the armouring, on top of the existing sand/silt/clay fill or native materials that will be exposed in the cuts, to minimize the potential for migration of fine soil particles into voids in the armouring layer which could result in future ground loss and subsidence. This layer could consist of the following, which will need to be taken into account when assessing excavation depths/volumes as well as fill material quantities:

- A geotextile separator fabric – however, note that this may be difficult to install below water, and would still require a protection/cushion layer of granular fill on top of the geotextile, to minimize the risk of rock edges puncturing/ripping the fabric. Depending on the nature of the contaminants present in the surrounding soils, a geotextile separator fabric that is intended to control the migration of fine soil particles may be substituted with a low-permeability geomembrane that is intended to also control the migration of dissolved or non-aqueous liquid phase contaminants into the river channel.

- A properly graded soil filter, on the order of 0.5 m to 1 m in thickness – this could be placed more readily below the water, and would likely consist of an initial layer of Granular B Type II, covered with a coarser layer of gravel, prior to placement of the armouring.







# 6 CONCLUSION

The refinement of information and design development for the Lower Don River / Port Lands Flood Protection Project, including elements of flood protection, naturalization, and the new public realm as presented in this report has contributed to progressing a cost estimate and plan of action that will enable the revitalization of the Lower Don River for future development.

The developments to the landscape design presented here have in general remained in compliance with the previous regulatory documents, with the exception of a few modifications listed below:

- The Cherry Street South Bridge is desired to be a signature bridge, of higher quality than the standard bridge design held in the 2014 DMNP EAR.
- The grading strategy for Villiers Island has been revised from the version submitted with the 2014 DMNP EAR. A preliminary strategy has been proposed here that will require further development and refinement.
- The Villiers Island stormwater system will need to be revised to reflect adjusted grading strategy for this area
- The layout of lake-connected and seepage wetlands will need continued refinement to ensure appropriate configuration for hydraulic function
- The selection of specific park program elements and layout will need significant refinement
- Specific design of the form, dimension,

armouring, and deformability of the naturalized channel of the Don River will be determined through further study

These modifications will need to be tested and verified in future design phases to ensure that they comply with risk mitigation efforts and the conveyance of the regulatory event, and individually reviewed to determine if additional approvals are required. These modifications have been accounted for in the cost estimate accompanying this report, and where appropriate have been included as a risk for cost of future modification in the risk assessment report.

It is understood that the material presented in this report is in-progress, and likely to change in the future. The intention of this report is to provide high level standards and quality expectations for costing purposes, and to identify areas of uncertainty for further design study.



# APPENDIX A

Flood Modelling Result Maps

Prepared by LimnoTech, Inc.



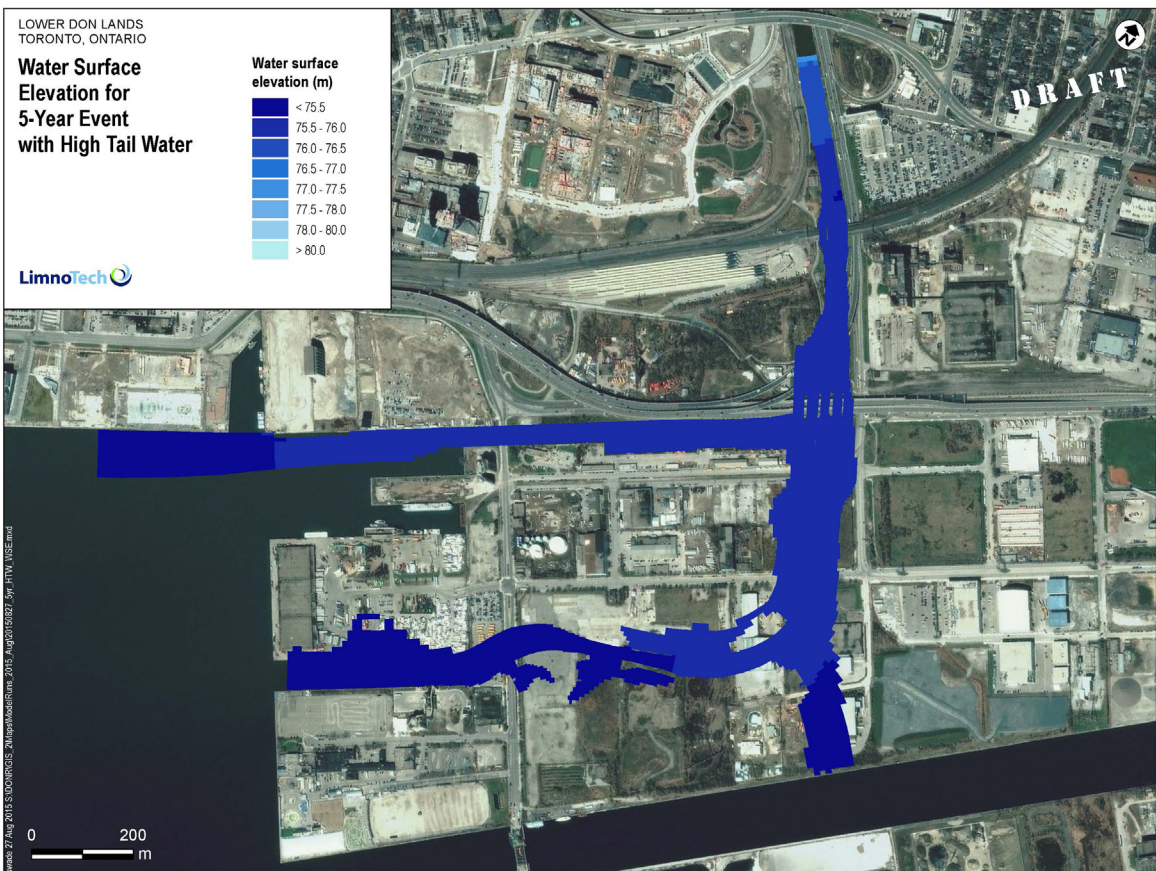
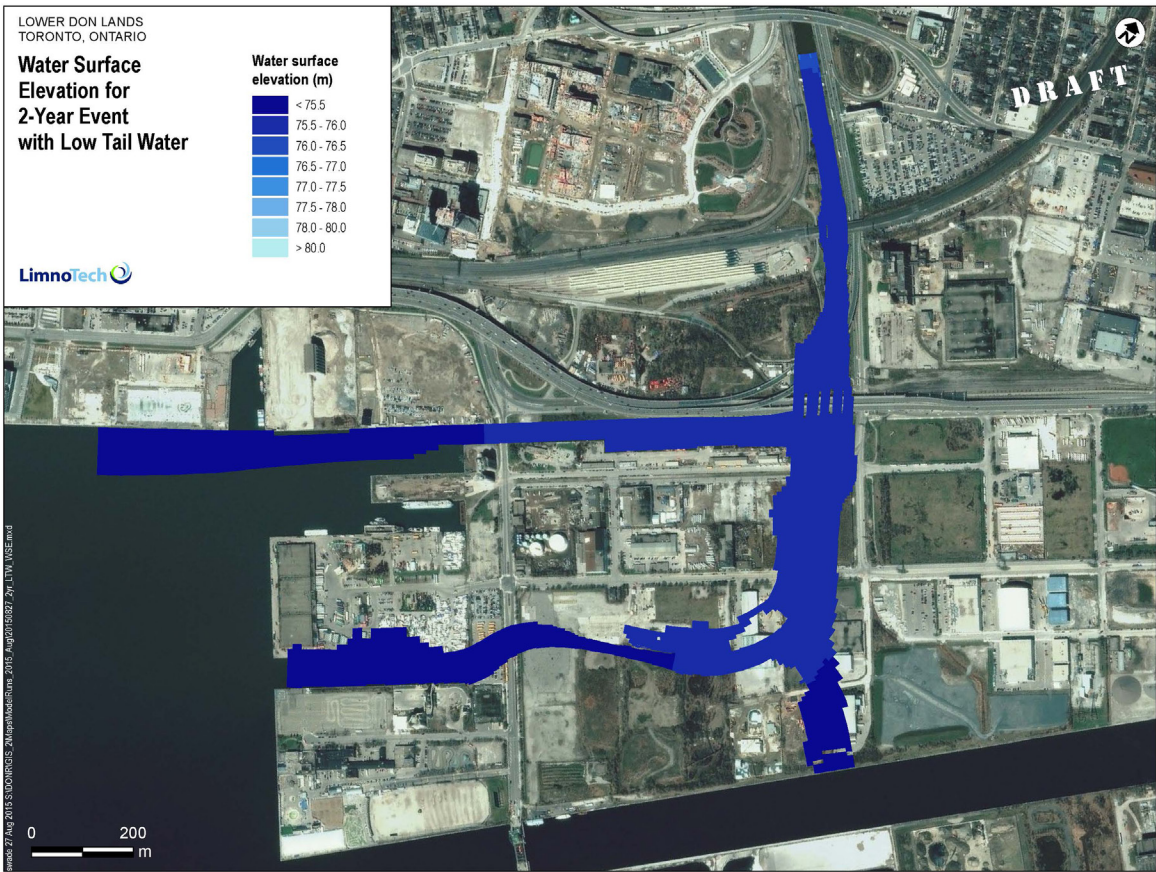

**APPENDIX A1: Water Surface Elevation**

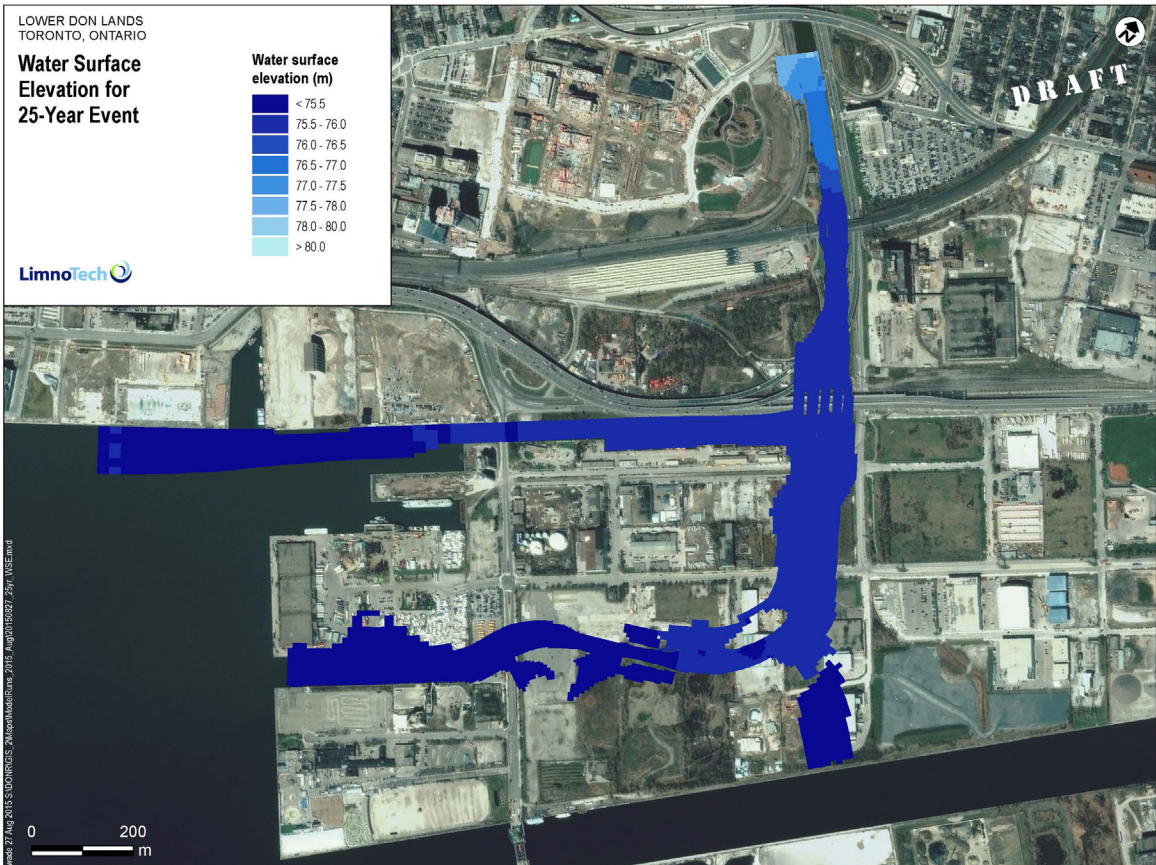
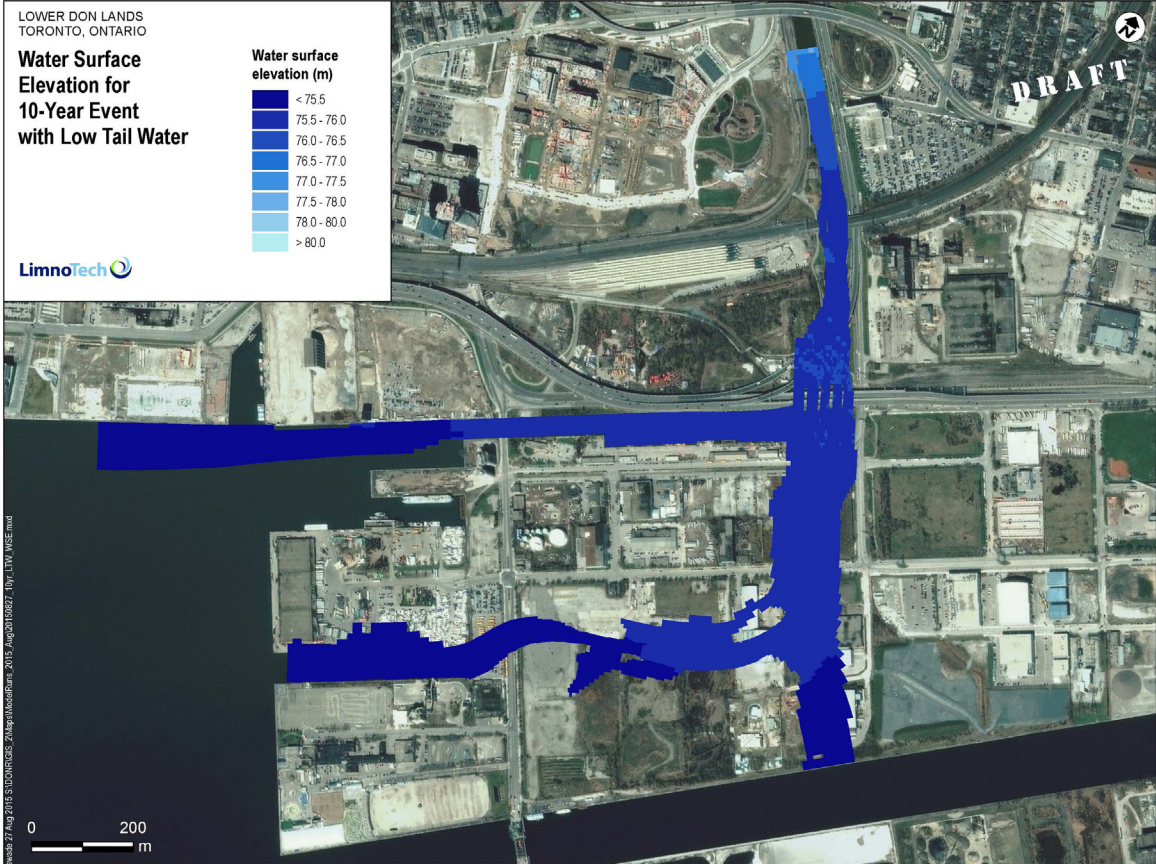

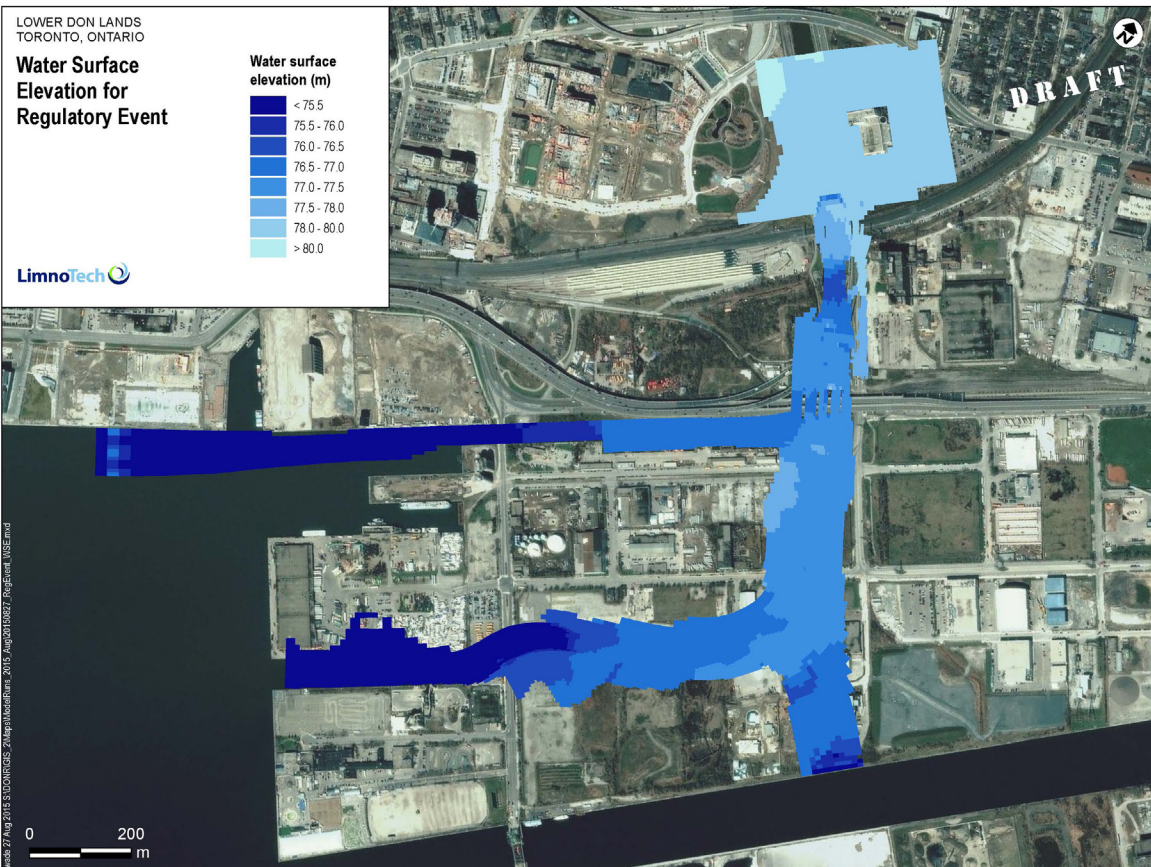
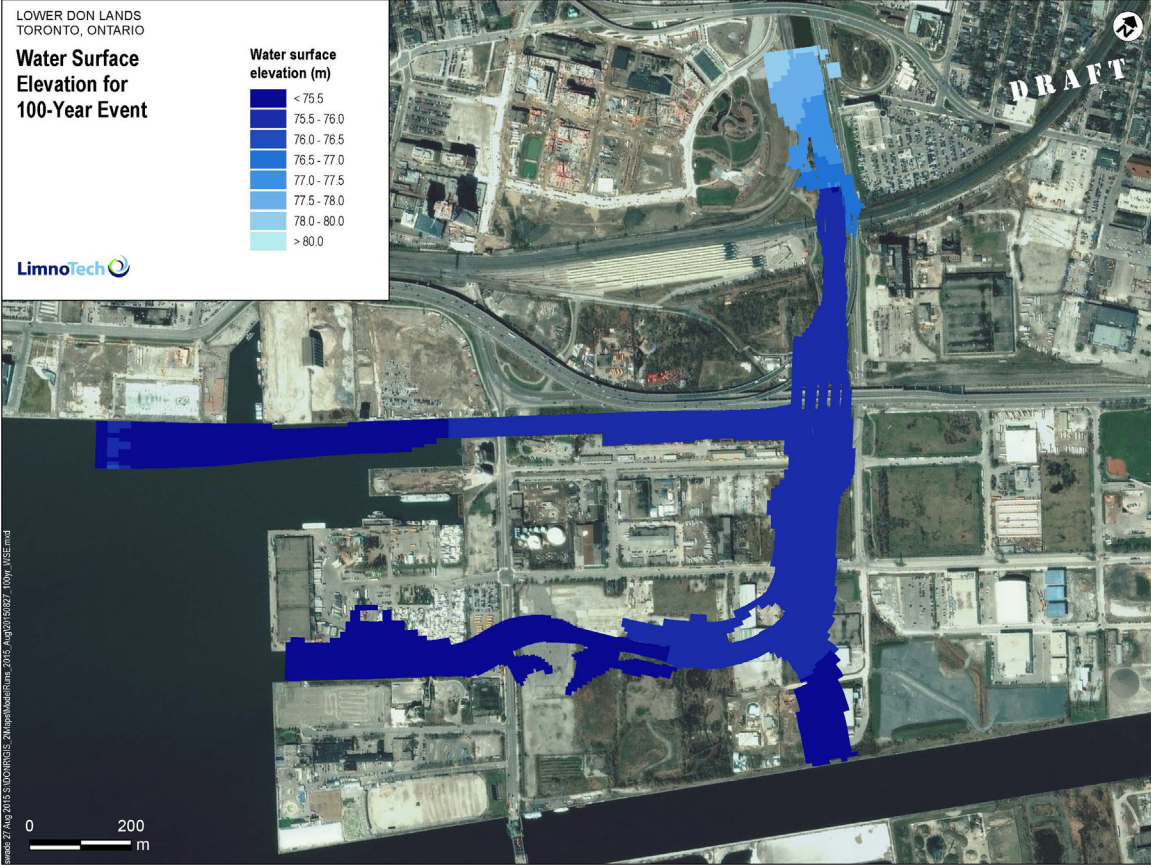

**APPENDIX A2: Water Velocity**

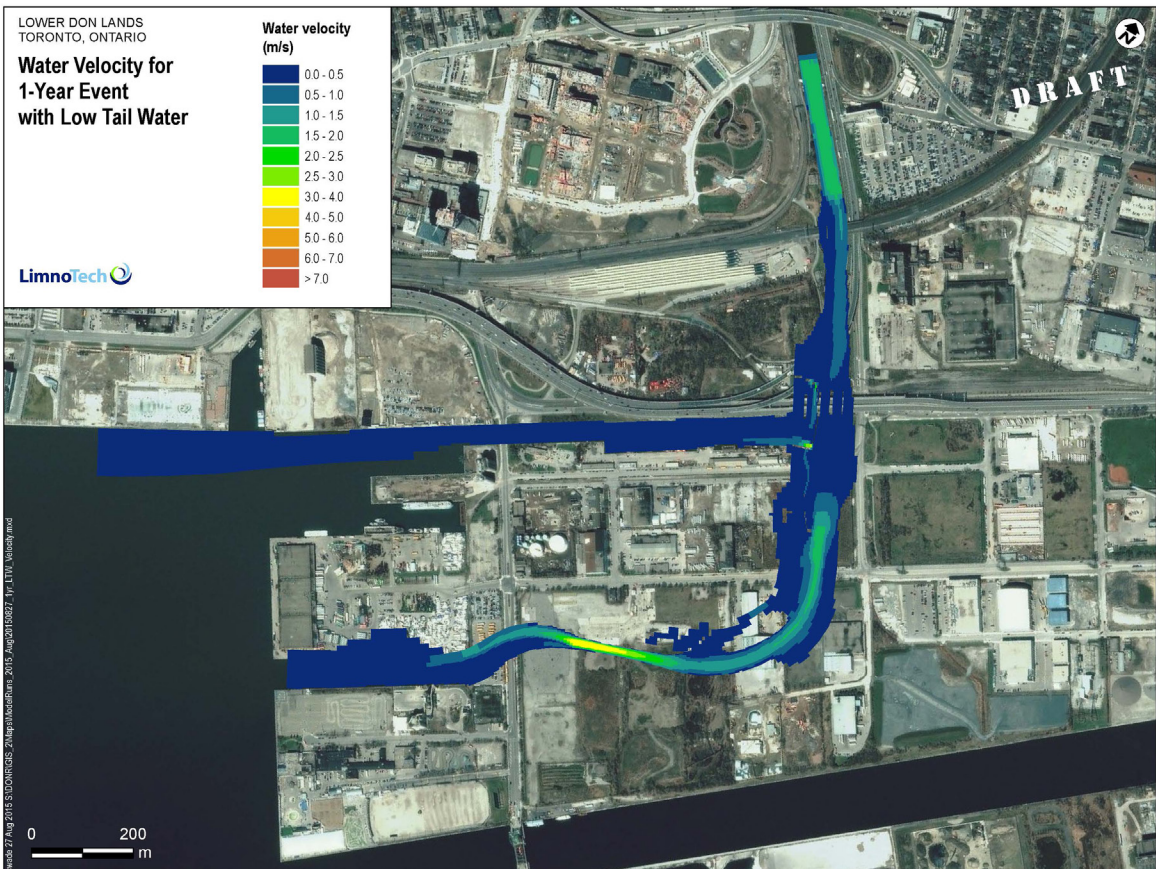
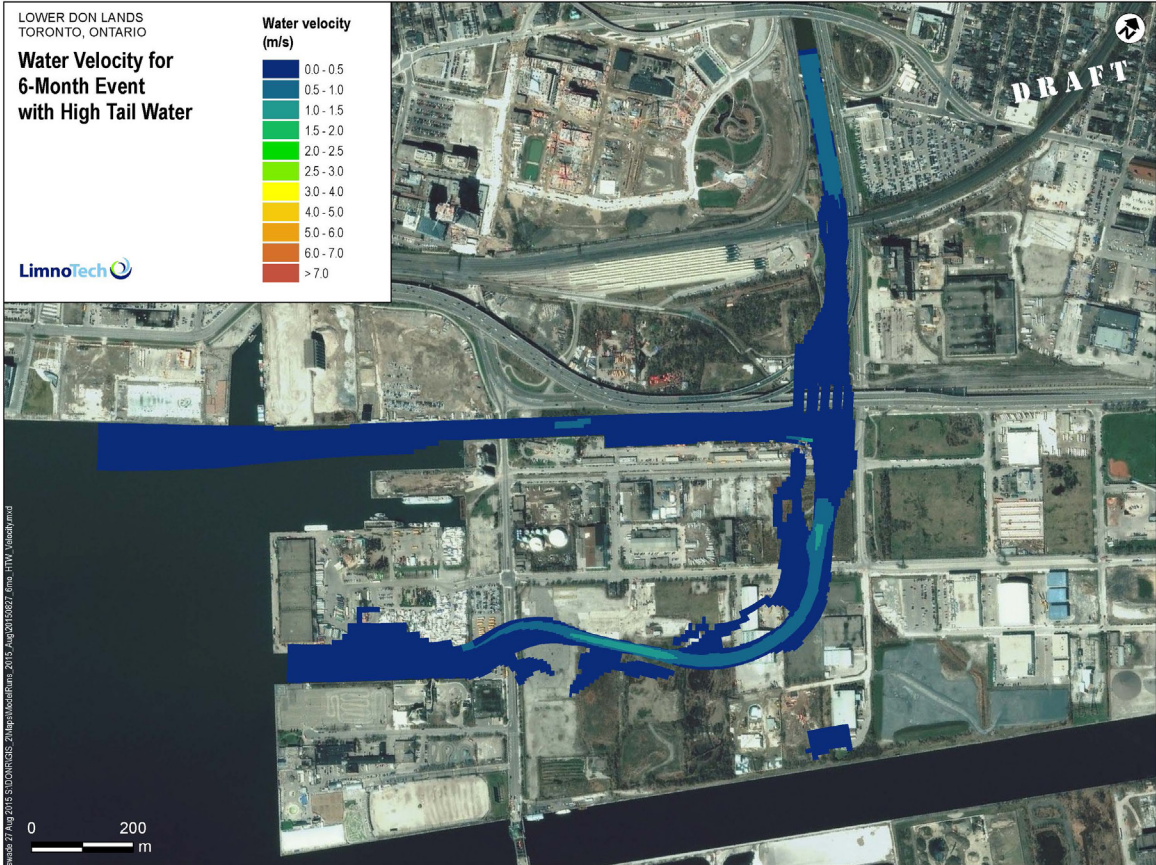



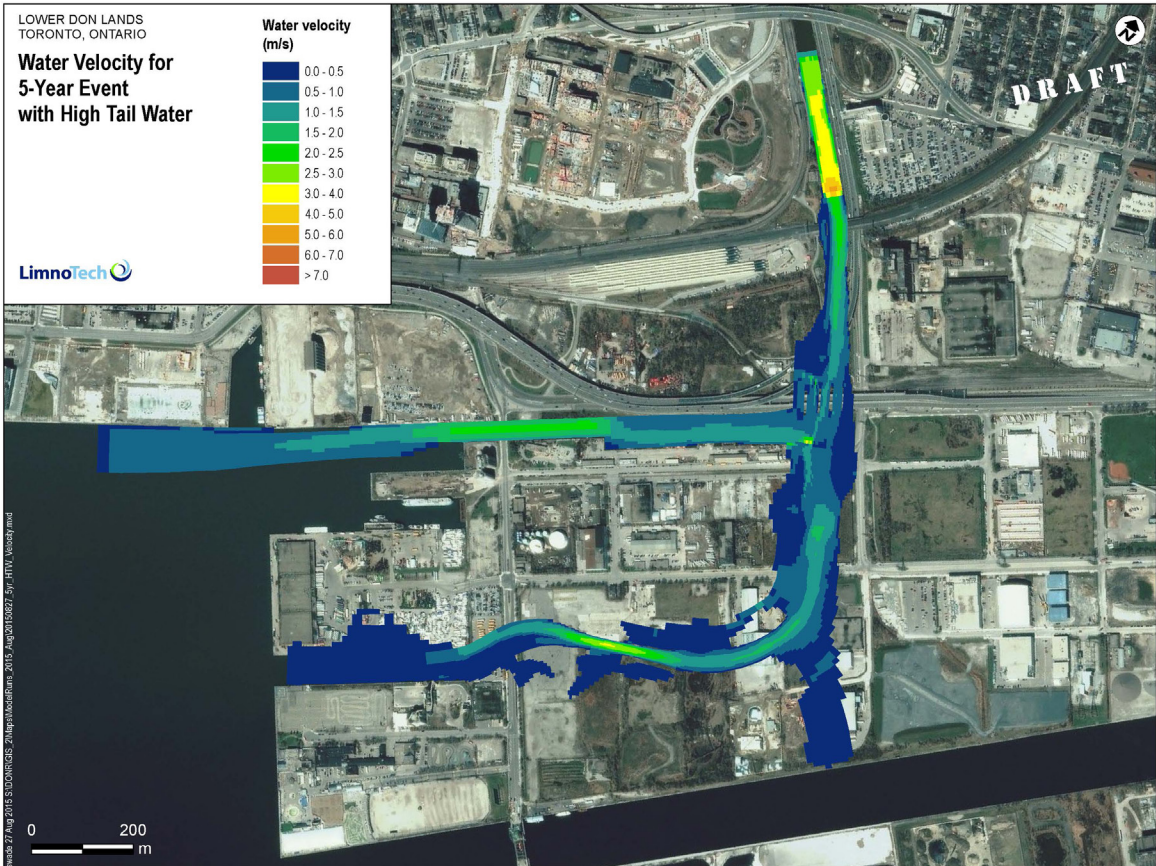
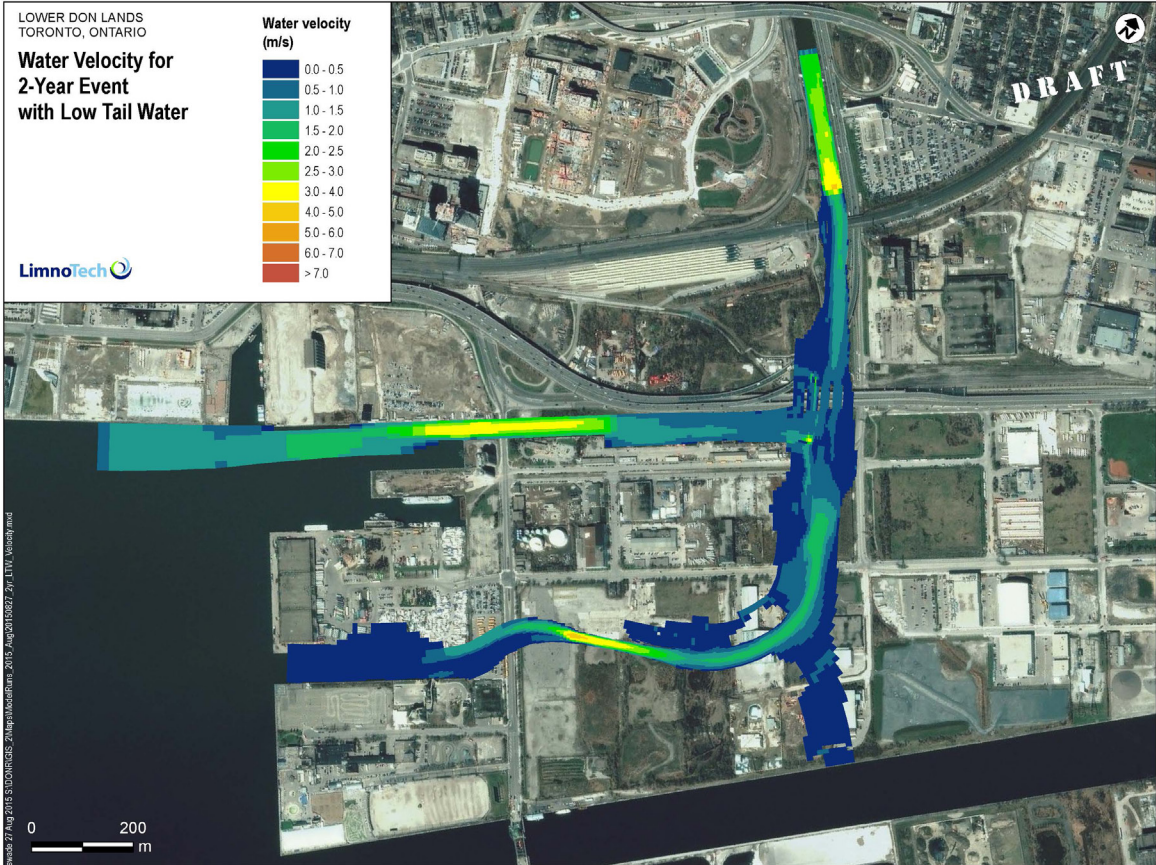

## APPENDIX A2: Water Velocity

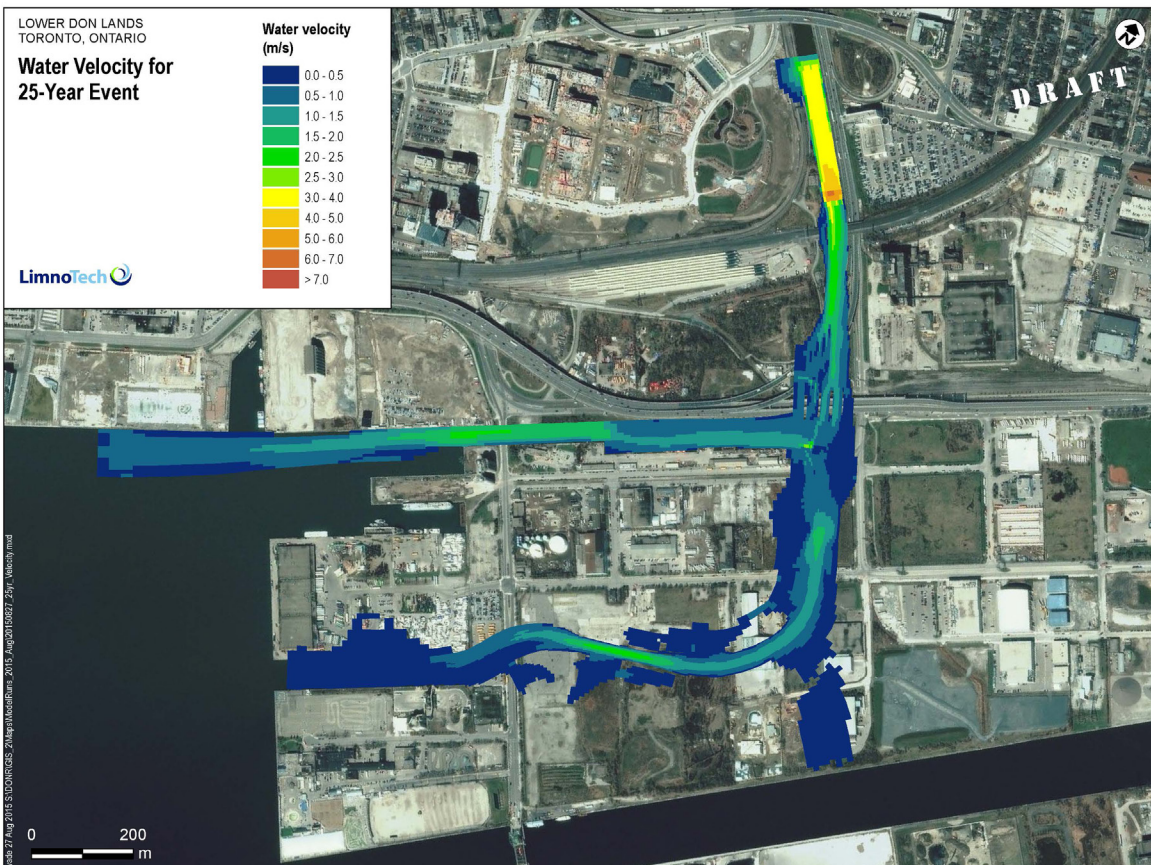
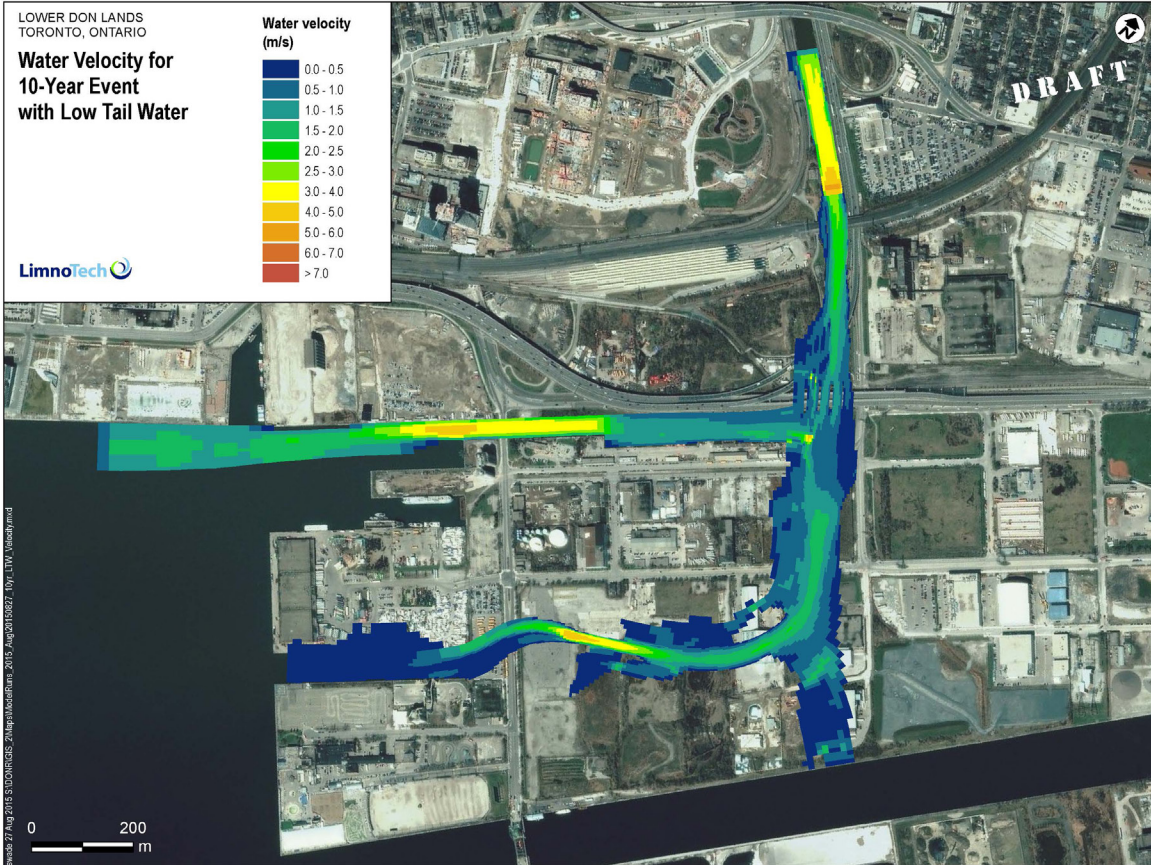

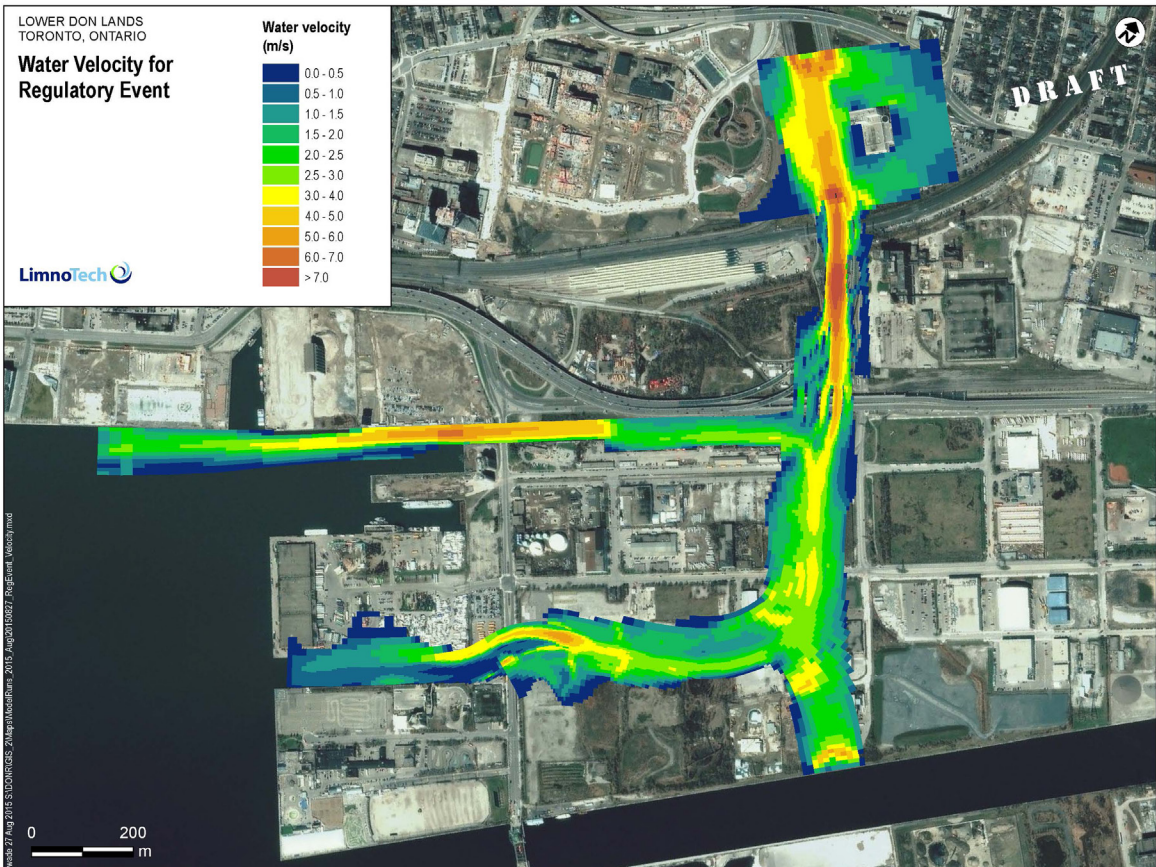
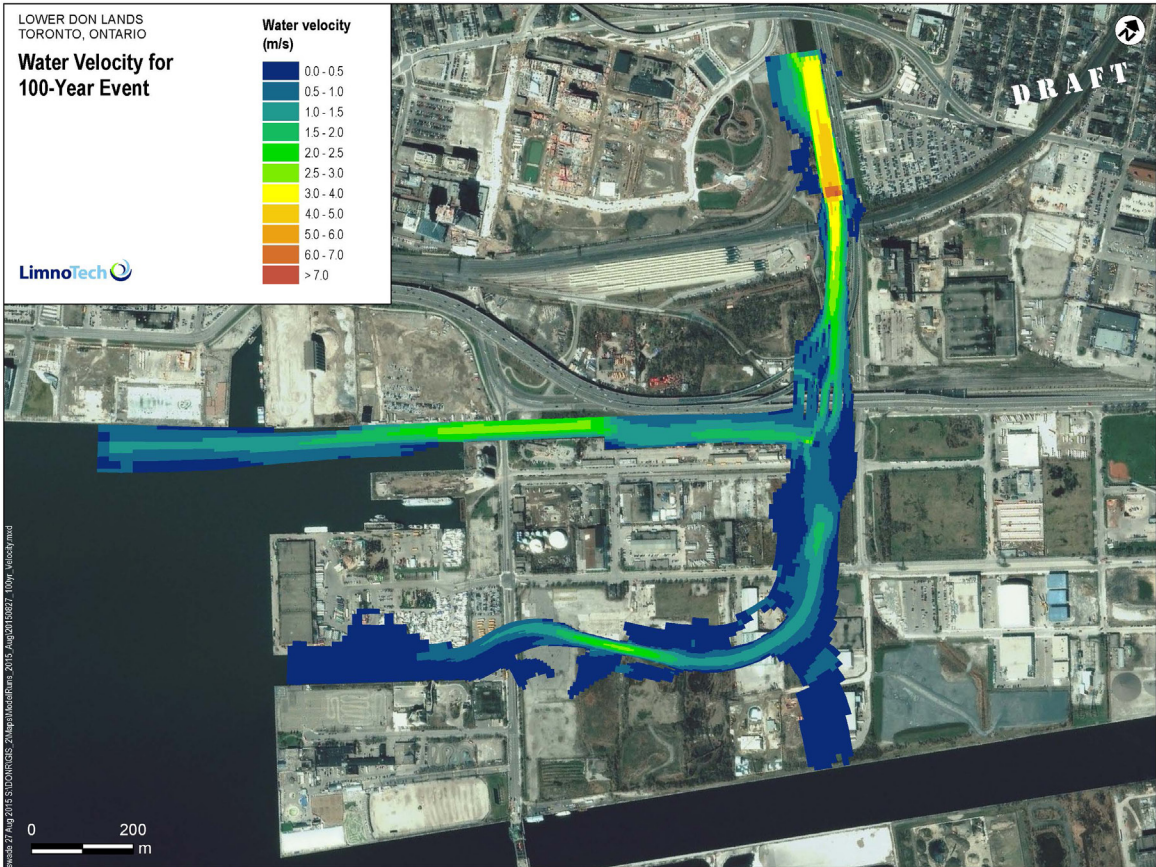

**APPENDIX A3: Shear Stress**

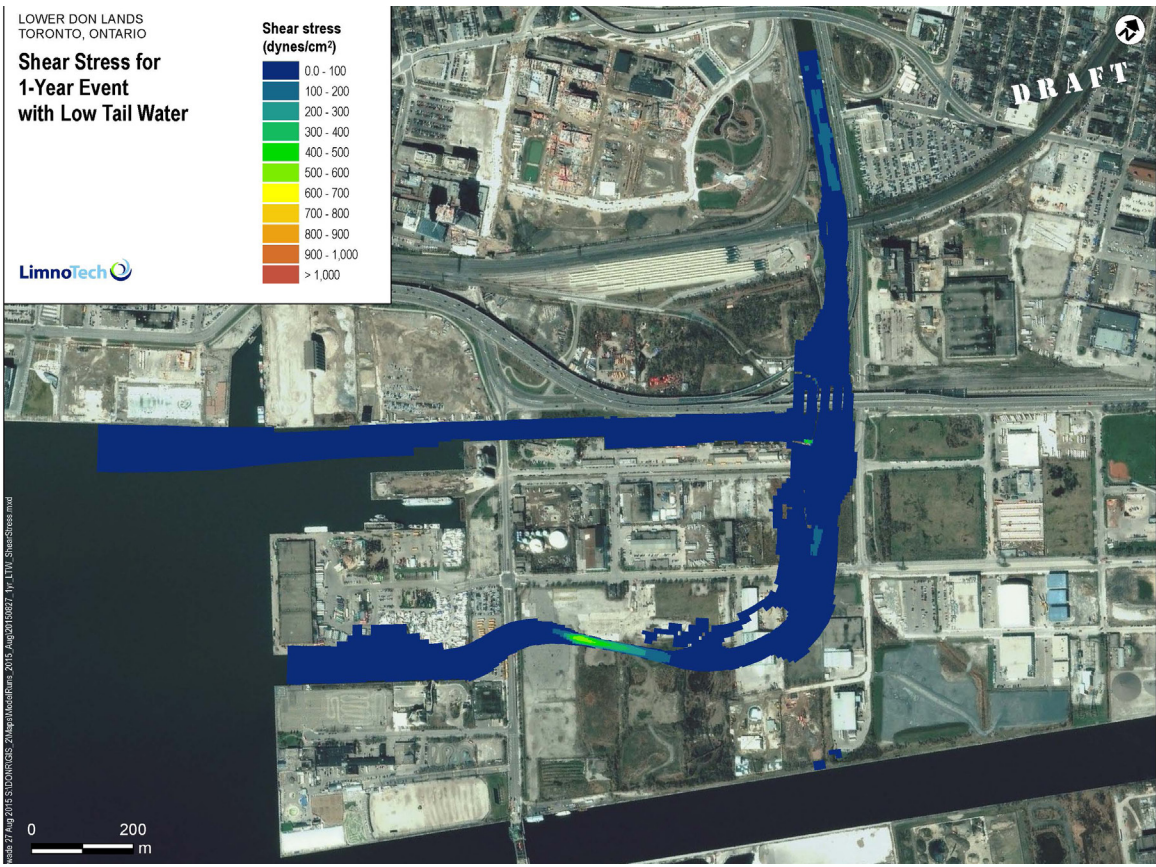
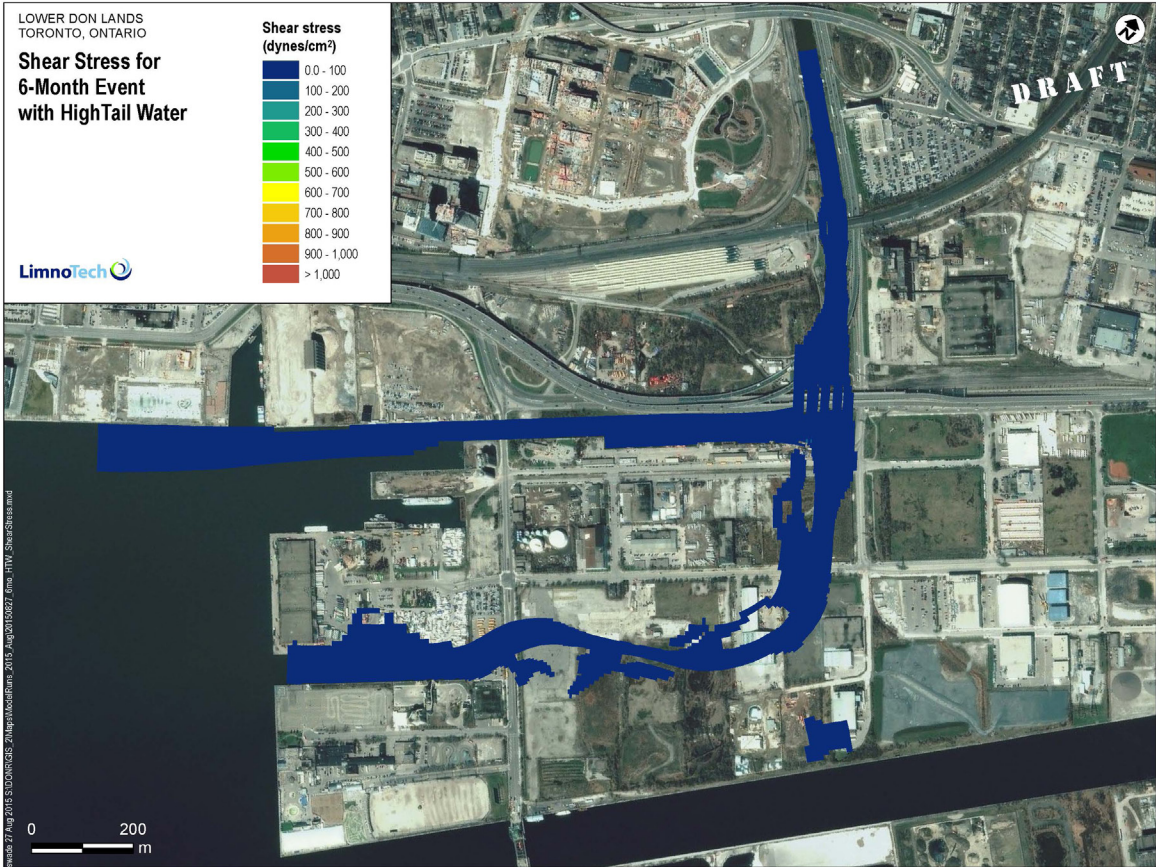

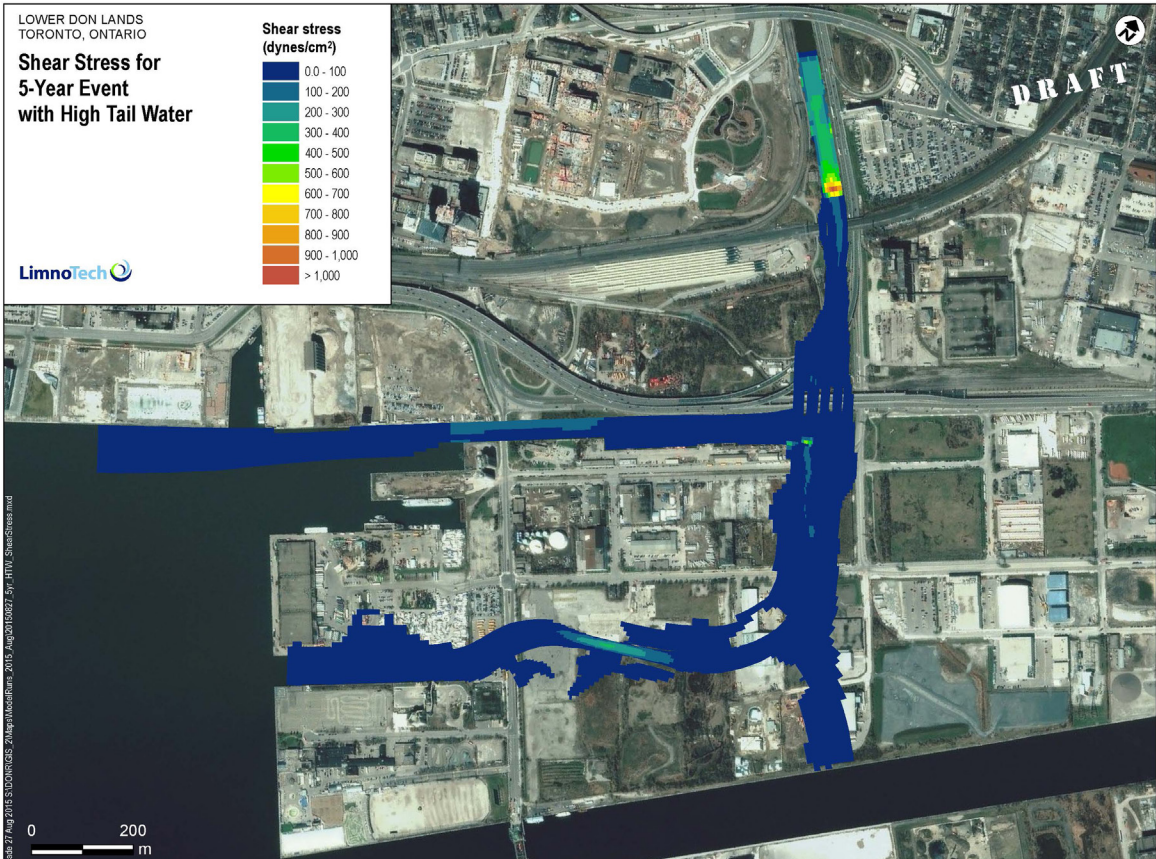
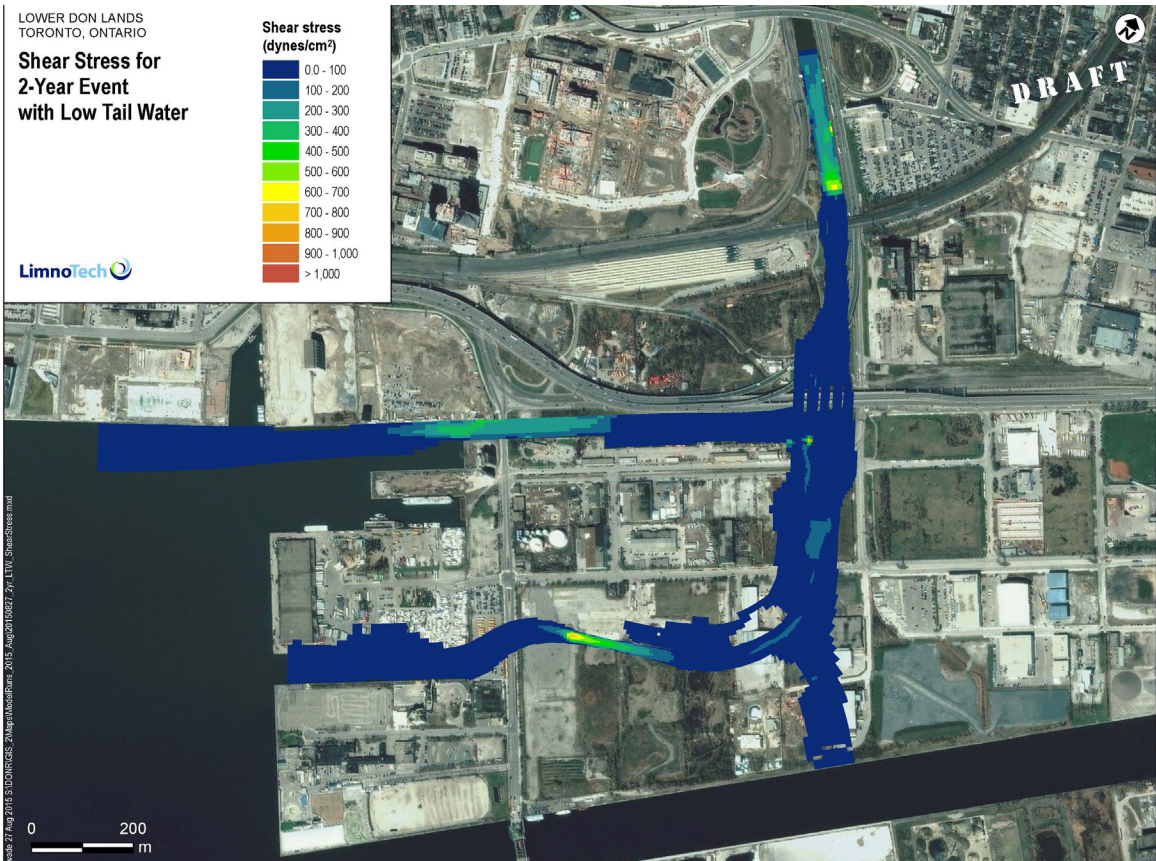

### APPENDIX A3: Shear Stress

LOWER DON LANDS  
TORONTO, ONTARIO

**Shear Stress for  
10-Year Event  
with Low Tail Water**

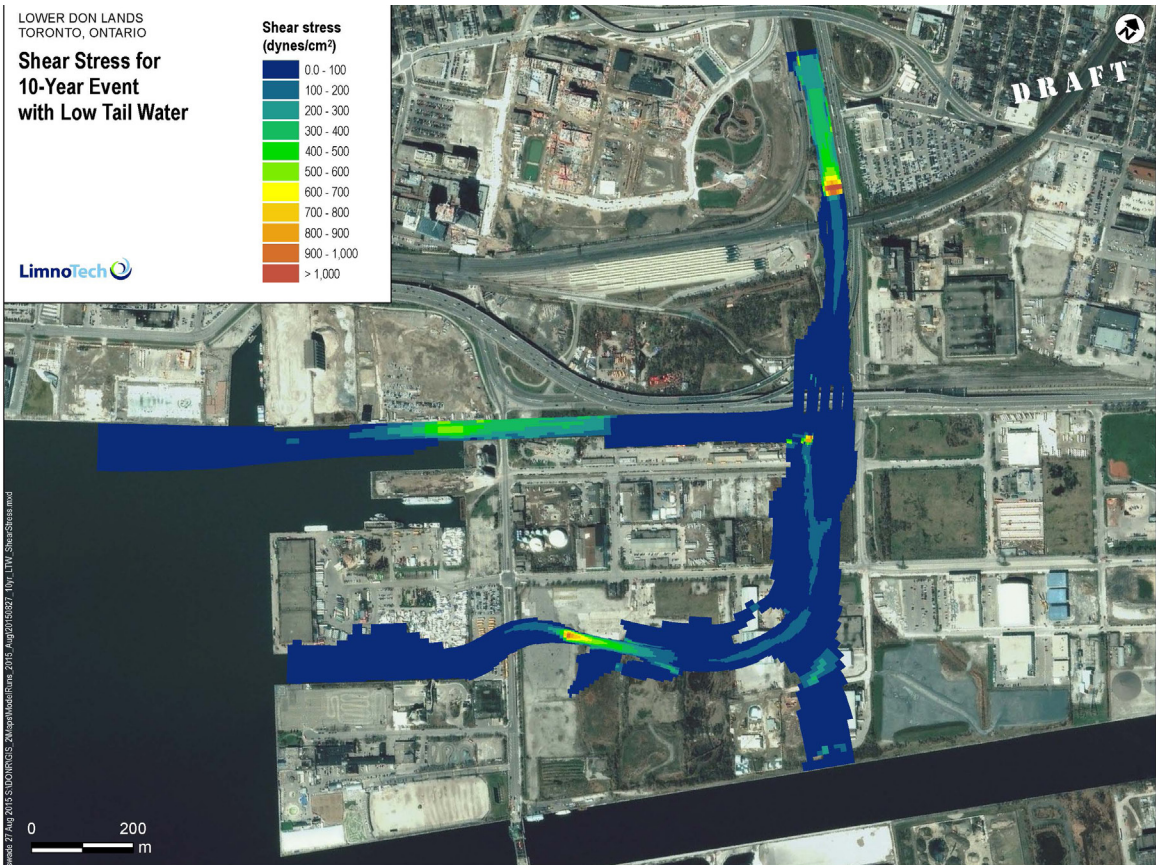
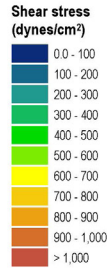

LOWER DON LANDS  
TORONTO, ONTARIO

**Shear Stress for  
25-Year Event**

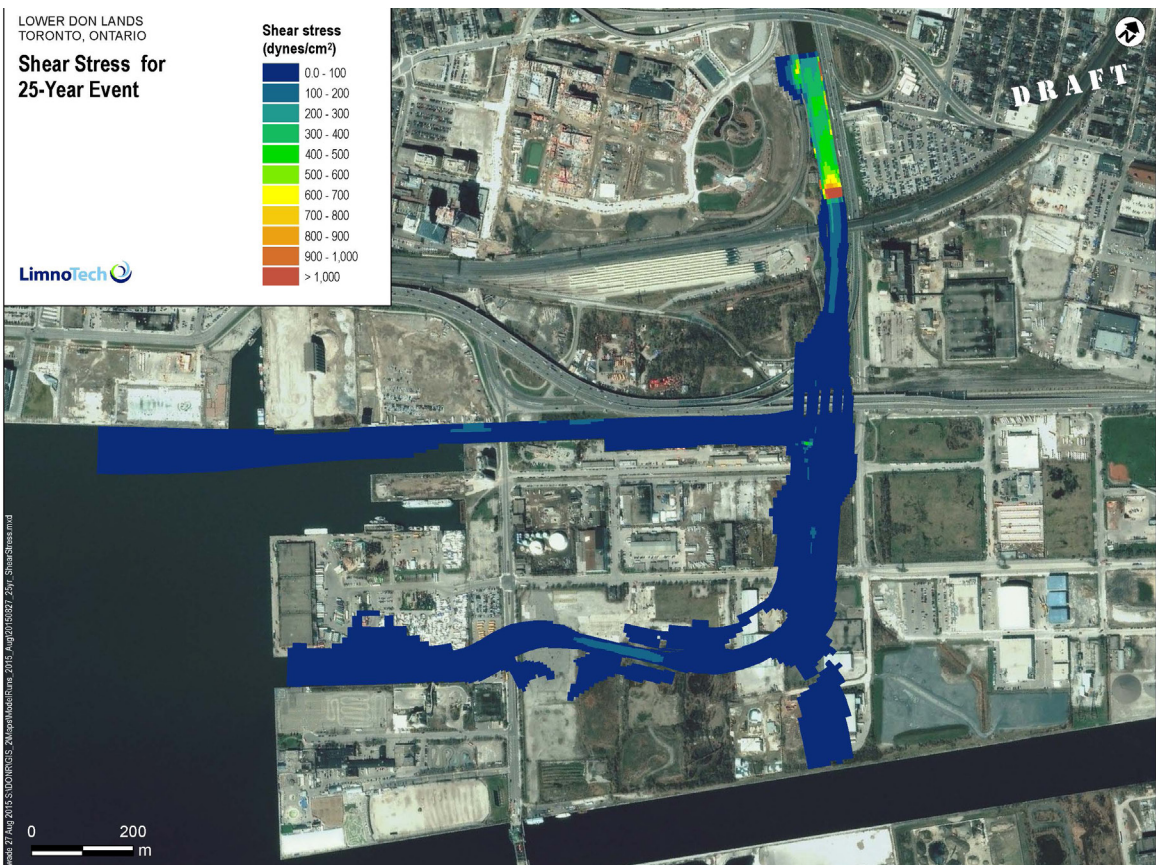
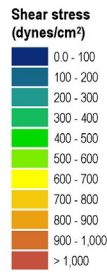

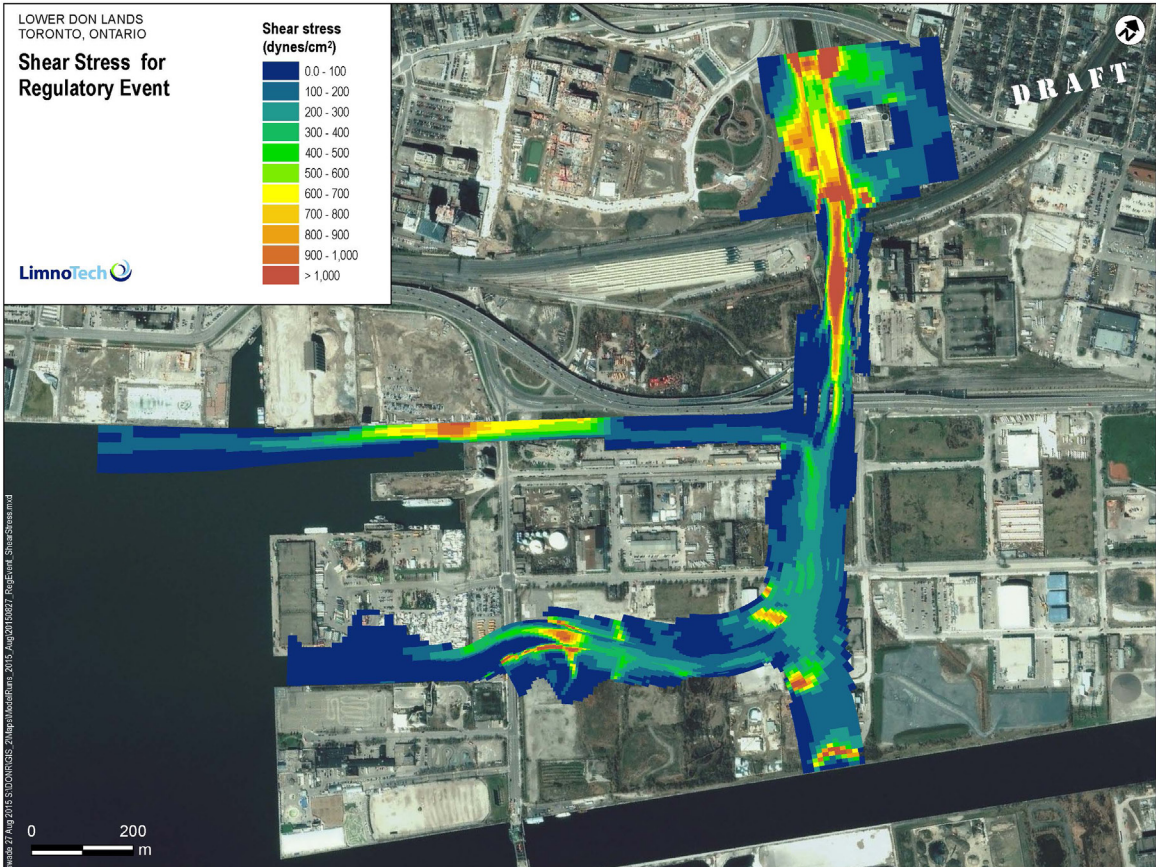
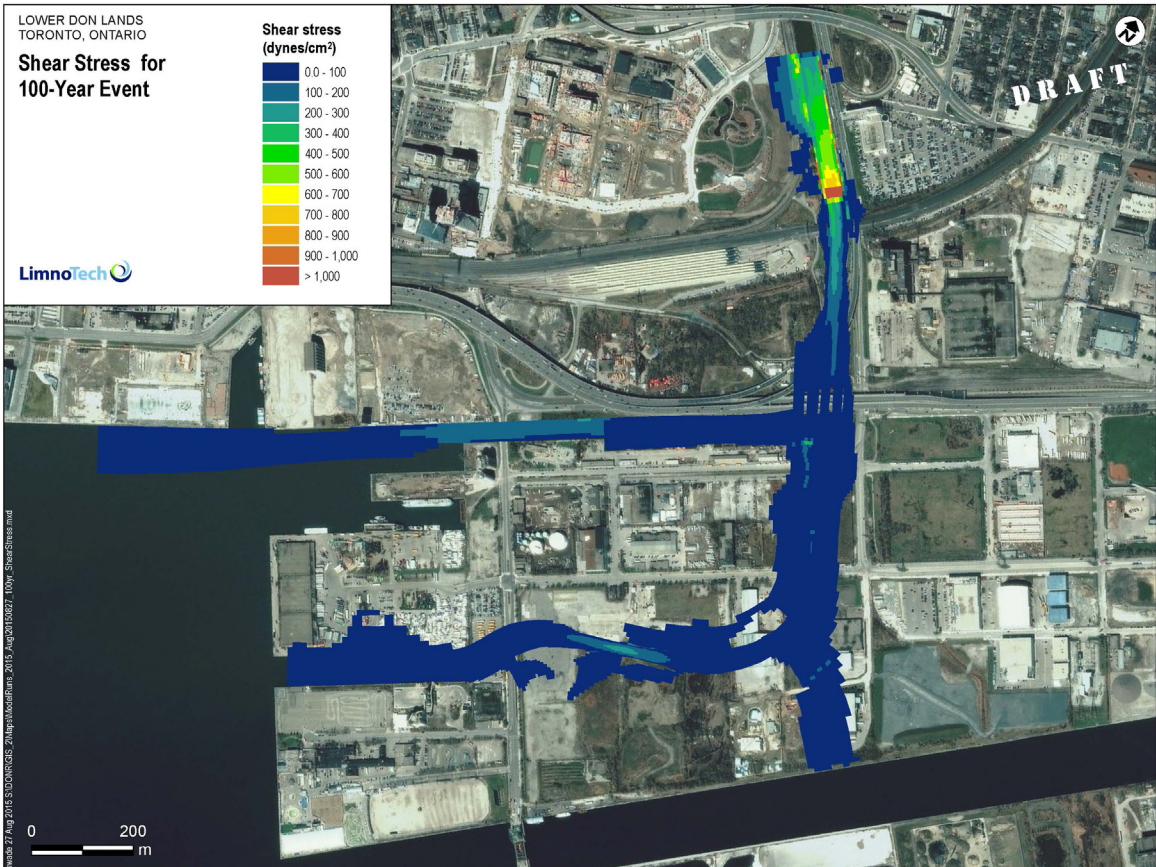

**APPENDIX A4: Critical Sediment Size at Initial Motion**

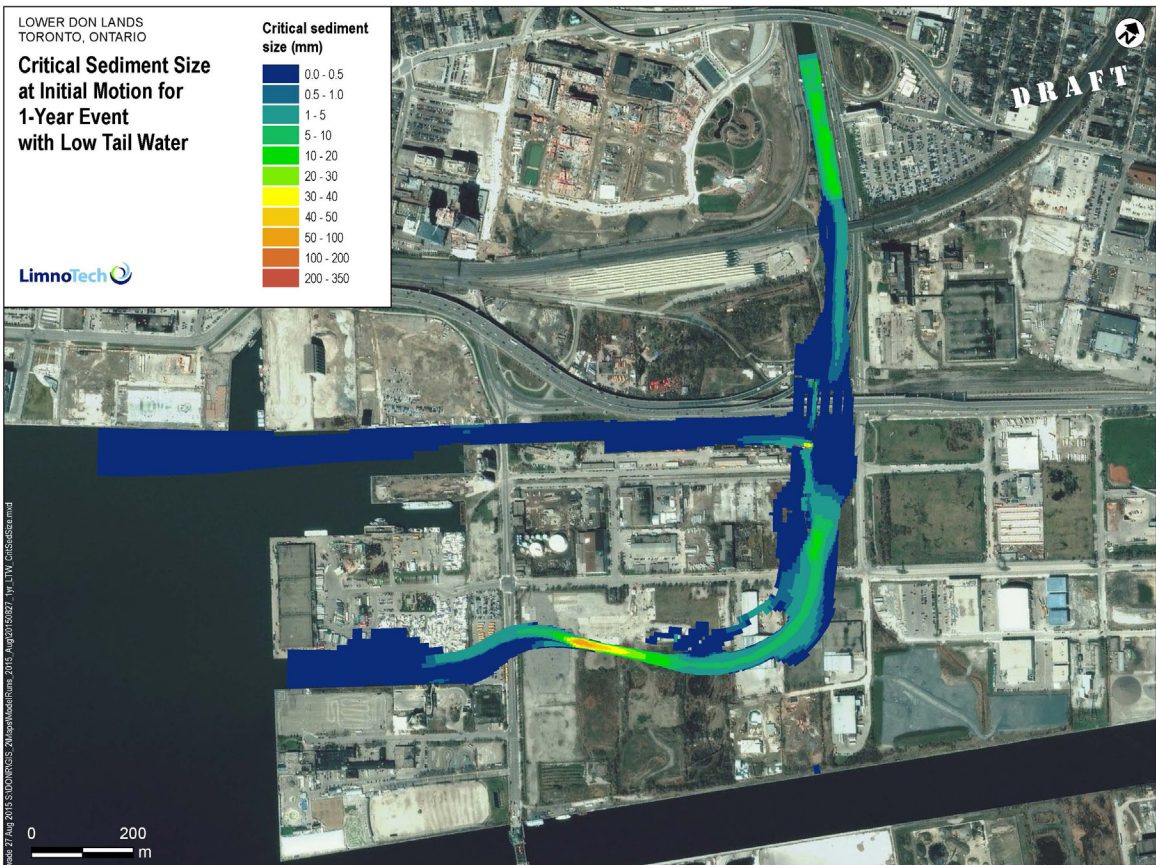
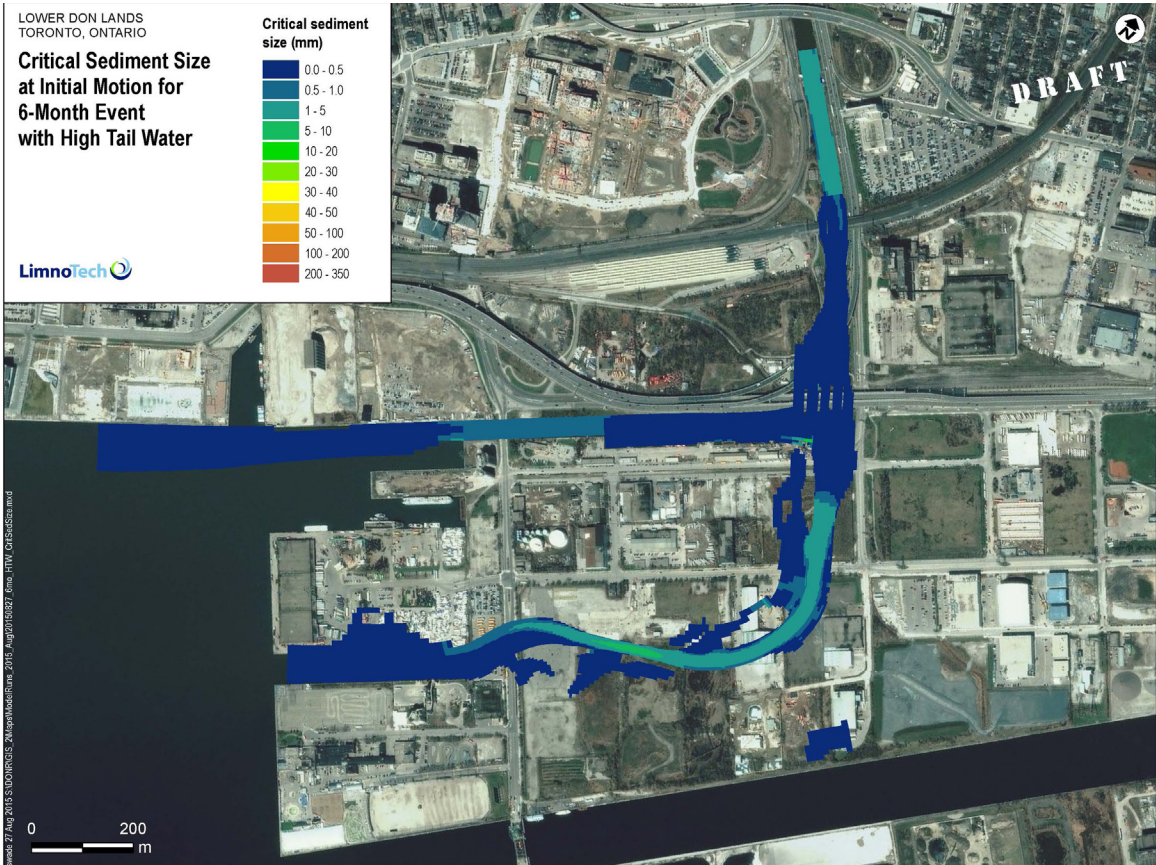



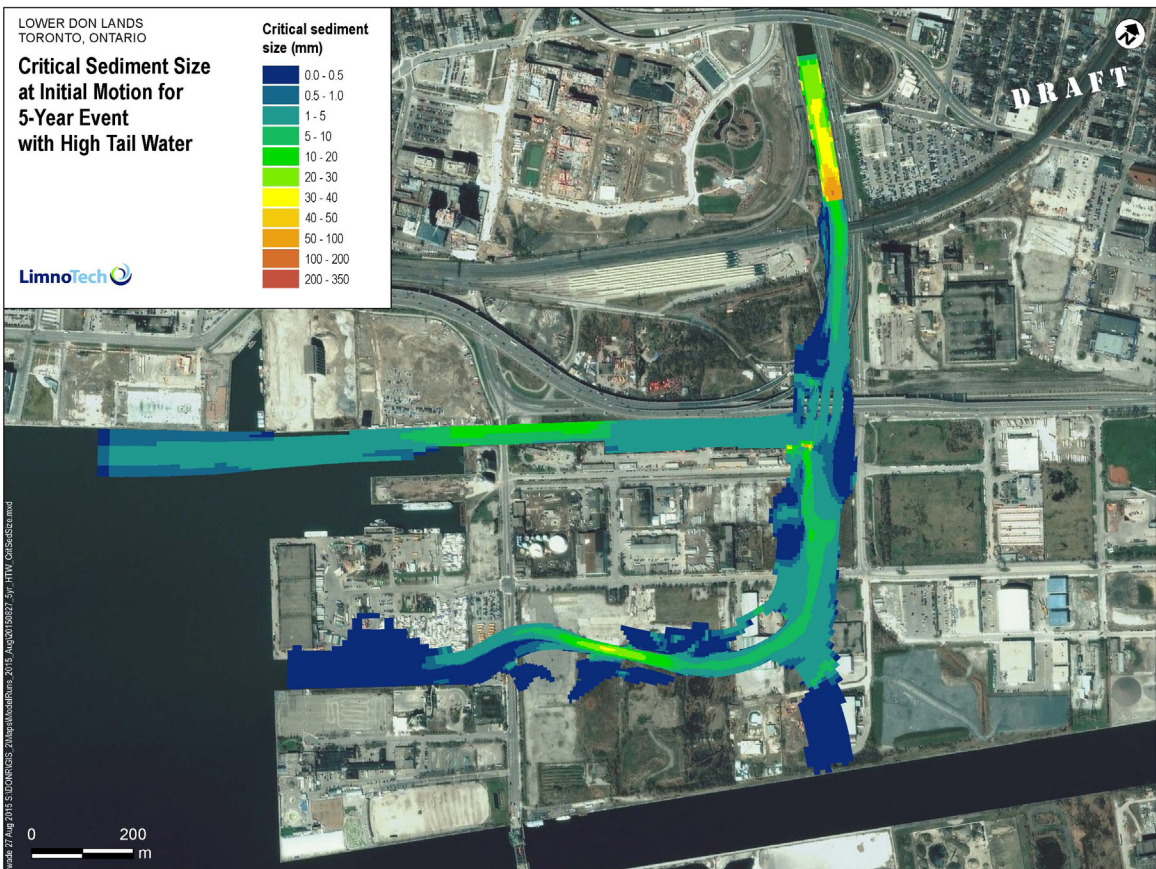
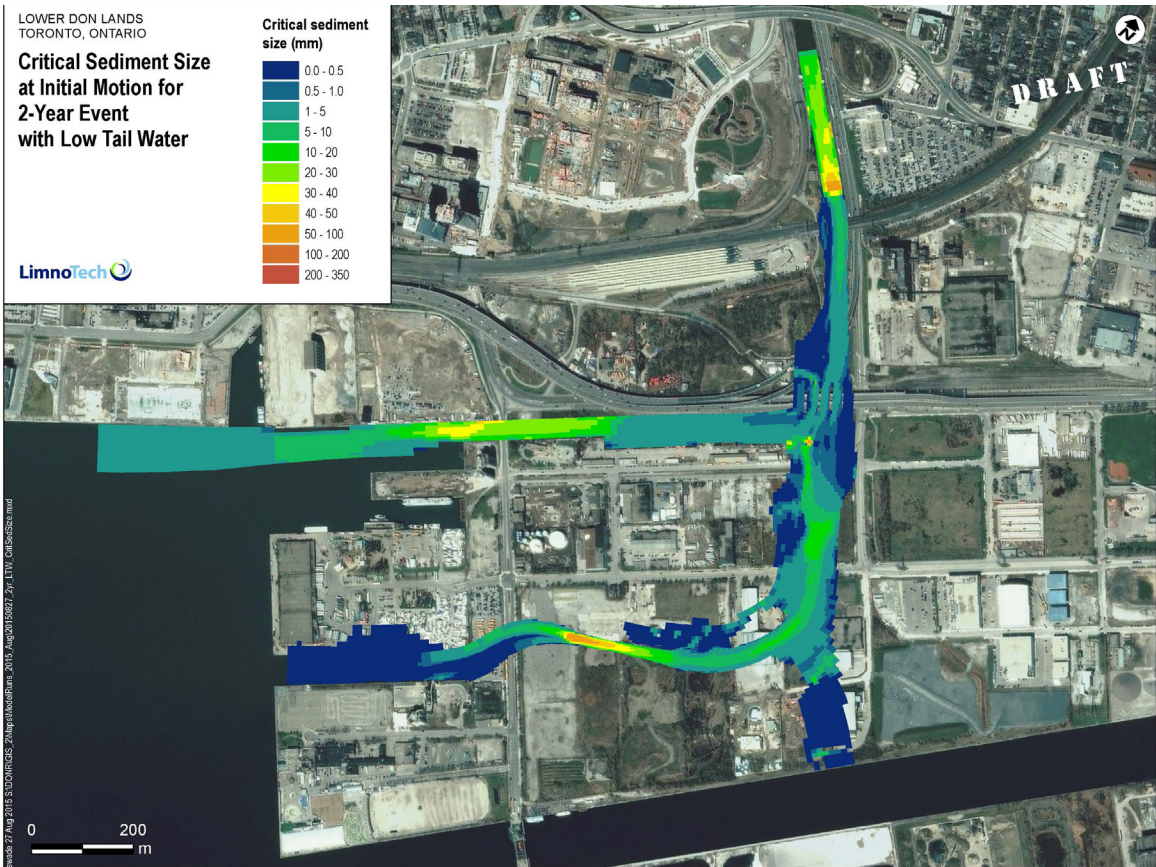

**APPENDIX A4: Critical Sediment Size at Initial Motion**

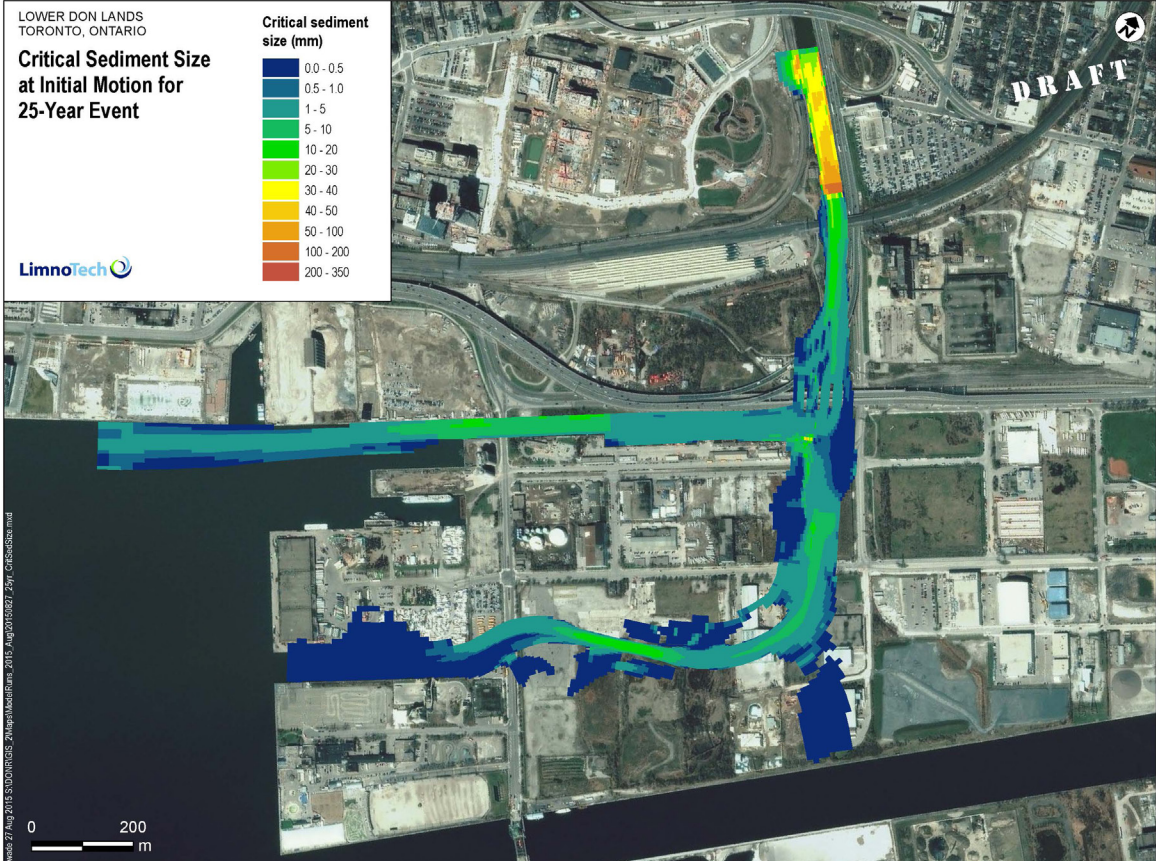
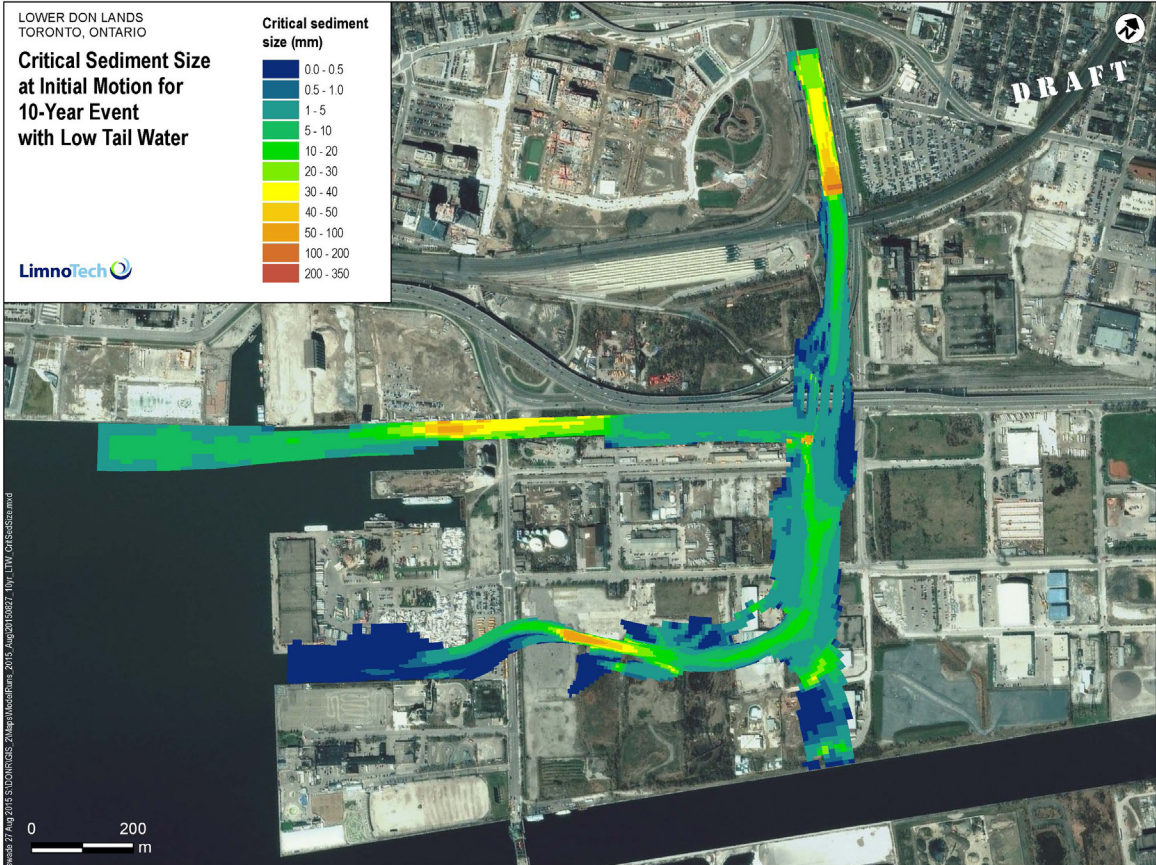

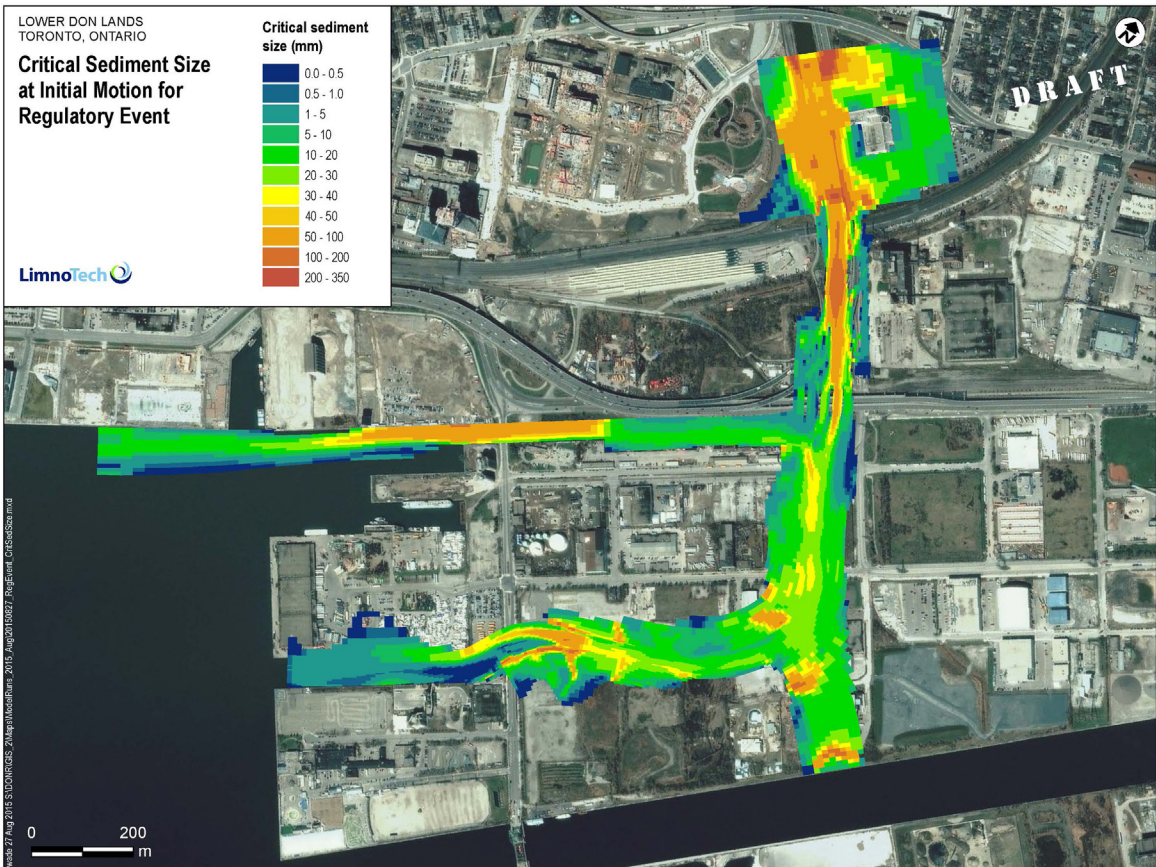
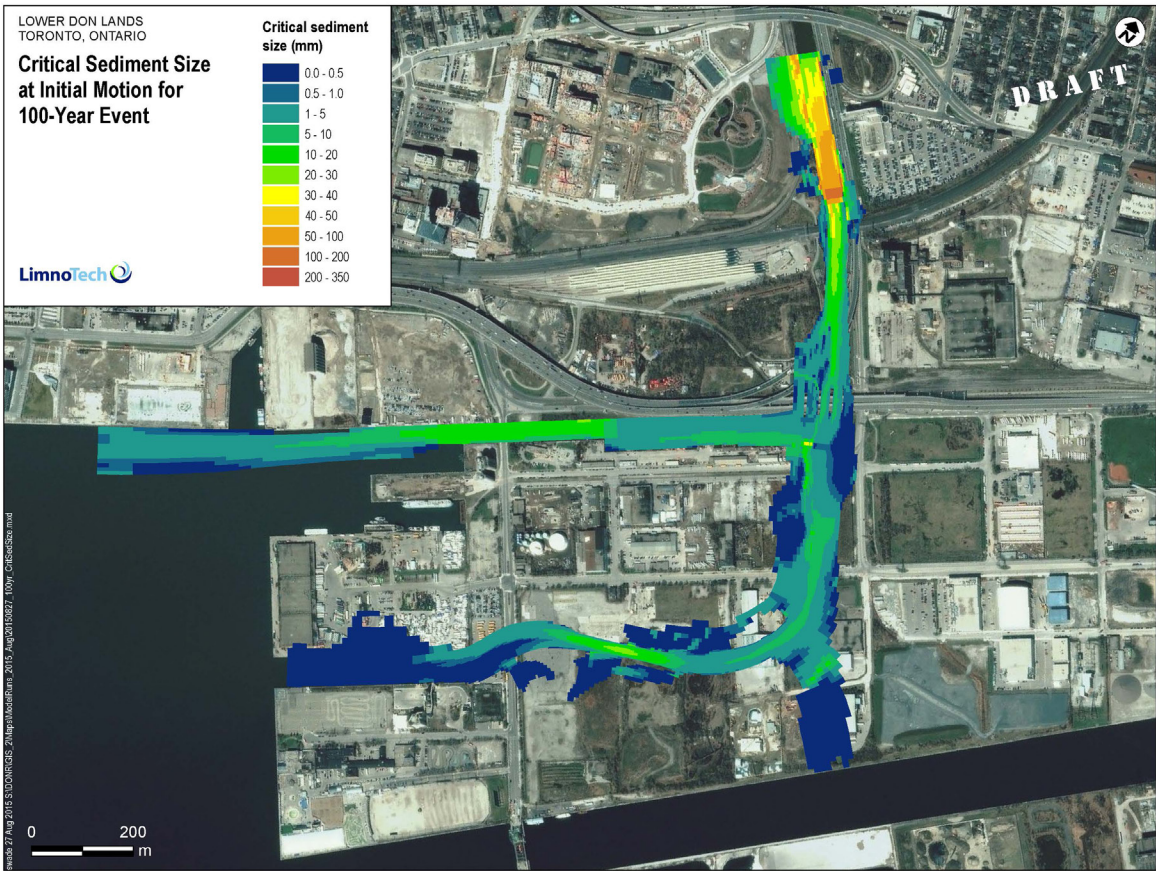

# APPENDIX B

Typical Conceptual Design Sections and Design Solution Fact Sheets

Prepared by Inter-Fluve, Inc.

# Typical Conceptual Design Sections

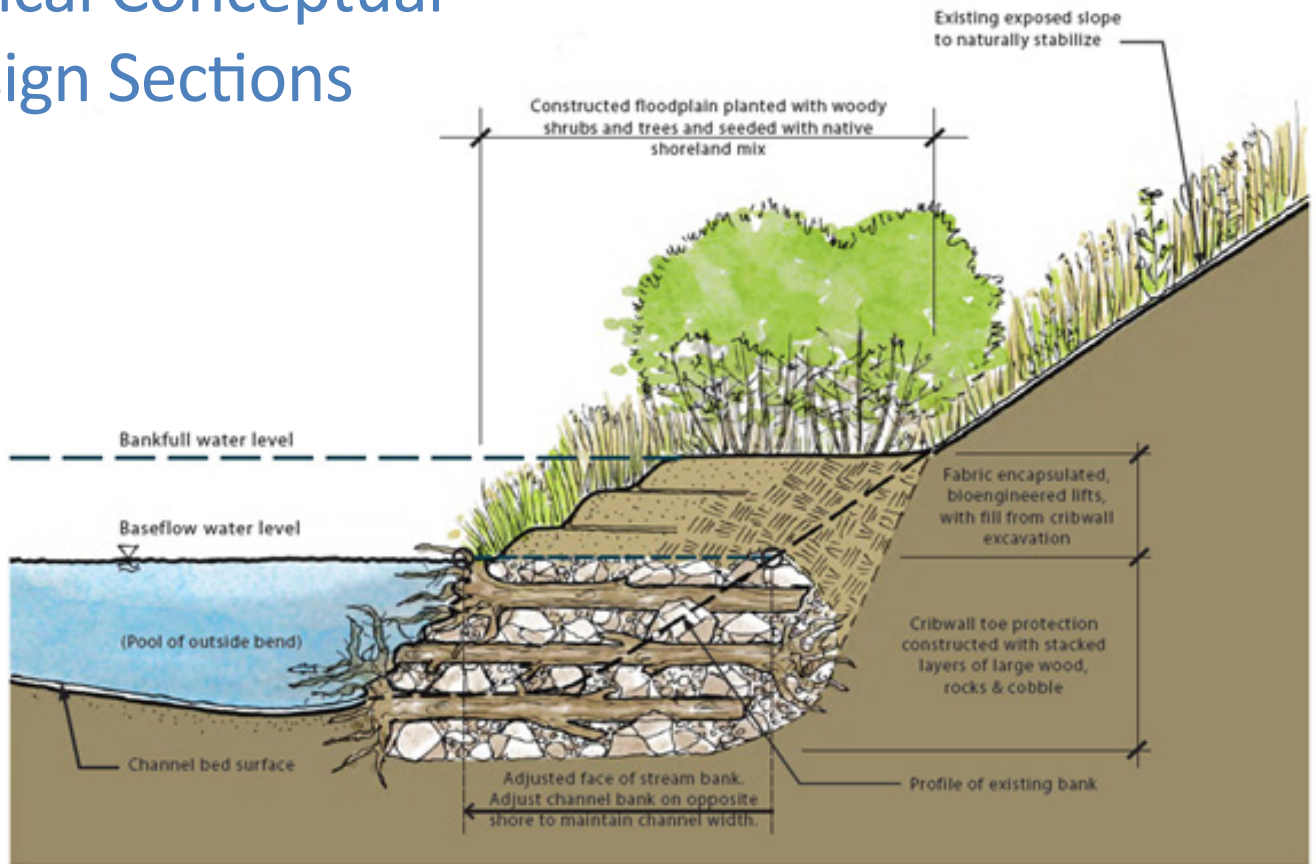

**Typical Section: Cribwall toe stabilization** n.t.s.

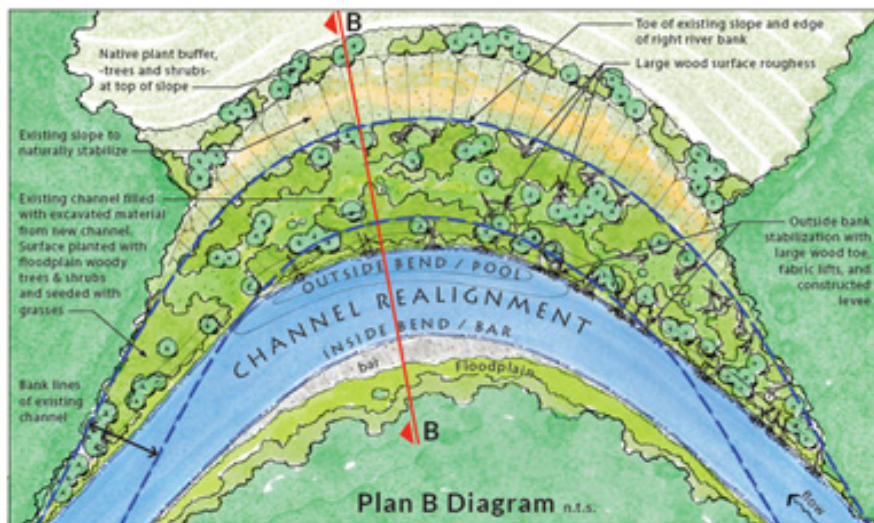
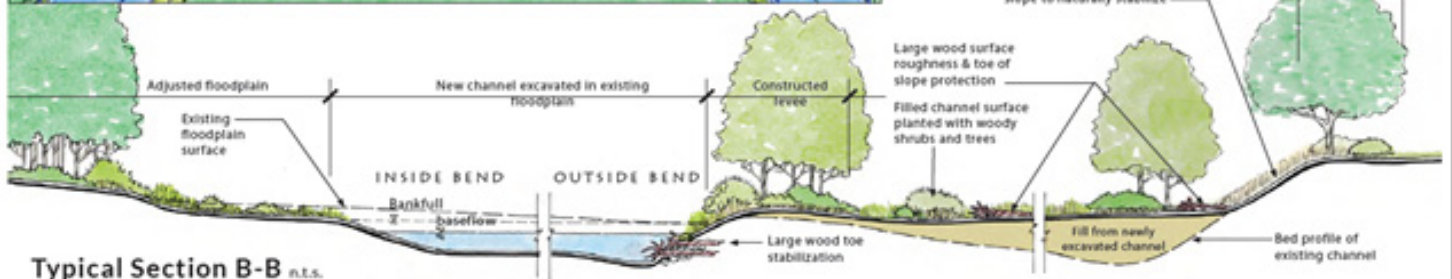

Image: Post-construction channel fill with large wood stabilization (pre-vegetation)



**Typical Section B-B** n.t.s.

# Design Concept: Engineered wood toe

## Design Concept Fact Sheet

**Overview:** In low shear environments where the long term stability of bioengineered banks depends on deep rooting vegetation such as trees and shrubs, large wood can be installed in the bank toe to provide erosion resistance. If partially submerged, large wood can last for many decades, providing short term stability (10-50 years) while allowing for long term channel migration if desired.

Large wood jams are multi-purpose, providing excellent channel stability, in-river habitat for fish, and nesting and resting habitat for birds, mammals, reptiles and amphibians. Wood can be designed to be low profile or deflective to minimize disturbance of paddlers.

### Project Goals Addressed:

- Fish Habitat
- Channel Stability

### Design Considerations:

- Site access
- Erosive power
- Buoyant and drag forces
- Recreational needs
- Aesthetics
- Habitat needs
- Inundation frequency

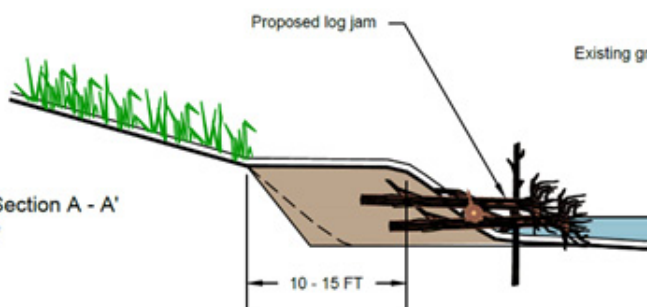

# Design Concept: Fishing access

## Design Concept Fact Sheet

**Overview:** When lowland alluvial channel restoration is completed and vegetation succession proceeds as planned, the riparian areas do not typically have clear areas where anglers can easily access the river. To avoid people clearing vegetation and generally trampling trails and bank areas, fishing platforms can be installed to target access for angling at places where fish may be found.

Fishing platforms can be constructed from wood cribs or stone, assuming a stepped profile to allow for access at a variety of flows. Alternatively, gravel bars can be constructed to target angler pressure and minimize trampling of natural bank treatments.

### **Objectives Addressed:**

- Recreational access
- Targeted access
- Shorebird habitat

### **Design Considerations:**

- Site access needs
- Inundation frequency
- Design flow shear stress
- Sediment deposition
- Plant community succession



# Design Concept: Constructed floodplain levee

## Design Concept Fact Sheet

**Overview:** Floodplain levees are shallow berms that develop on the banks of low gradient alluvial rivers with an abundant sediment supply. During large floods, coarse sediments such as sand deposit near the banks where large momentum changes occur. These sediments build up over time and form natural levees.

In river restoration design, these levees can be built from encapsulated soils and can provide multiple benefits, including separation of riparian wetland features, variation in hydric soil conditions and subsequent variation in planting strategies. Where trees are needed for bank stabilization, levees can create slightly dryer conditions to allow for trees to establish.

### Objectives Addressed:

- Flow training
- Floodplain hydrology
- Soil moisture variability
- Planting variability

### Design Considerations:

- Site access needs
- Inundation frequency
- Design flow shear stress
- Sediment deposition
- Plant community succession
- Recreational use

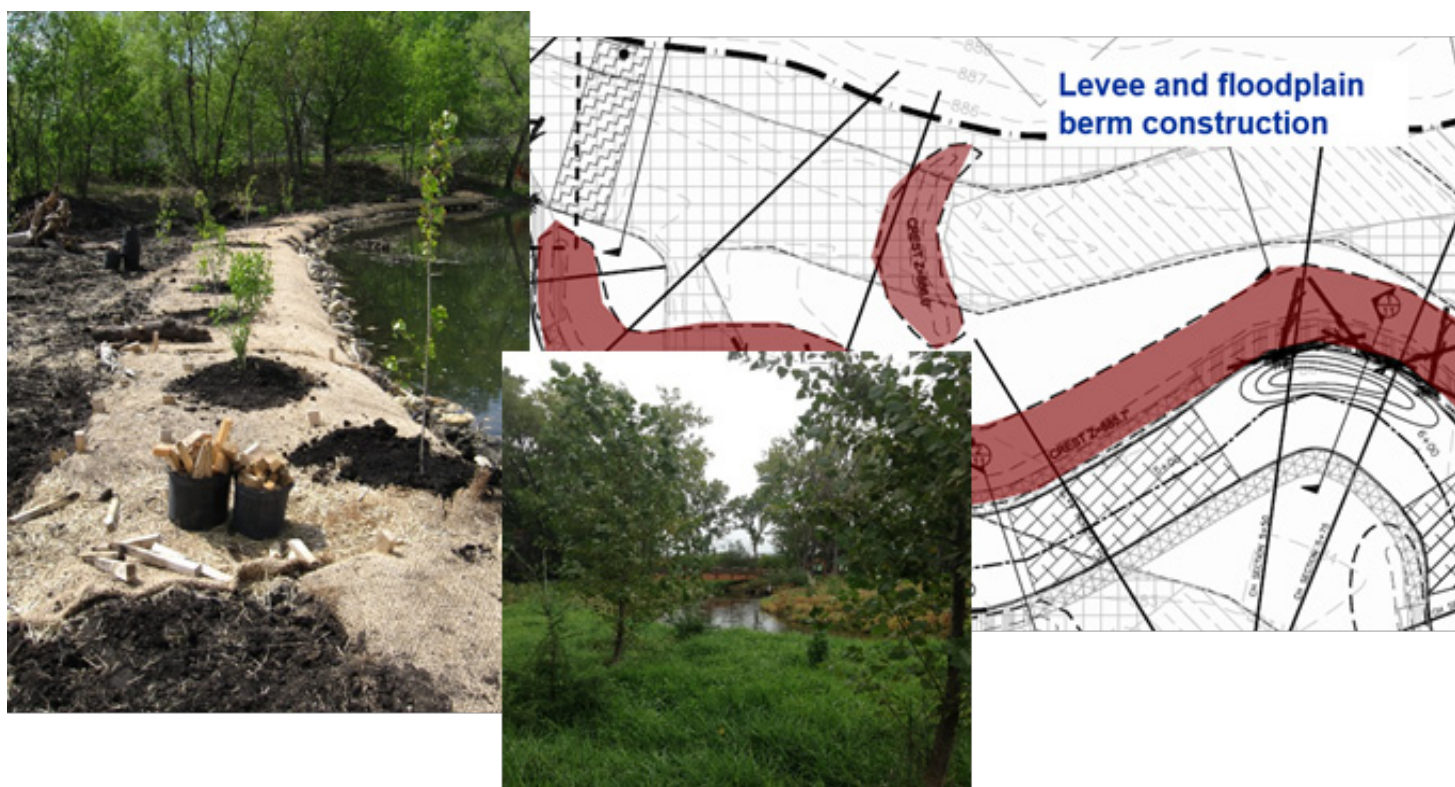



# Design Concept: Gravel bar

## Design Concept Fact Sheet

**Overview:** Gravel bars are installed on the inside of meander bends, or occasionally on straight segments of larger rivers. Point bars occur naturally on alluvial rivers, but constructed gravel bars are generally used in areas of high trampling or in targeted use areas where access is desired for canoe or kayak launching, fishing or just getting close to the water. Gravel bars can provide important shore bird habitat for a variety of species.

The siting of gravel bars is determined by site erosive forces, sediment transport constraints, site recreational use, and the proposed plant community succession. Not every site is amenable to sustaining gravel bars.

### Objectives Addressed:

- Recreational access
- Targeted access
- Shorebird habitat

### Design Considerations:

- Site access needs
- Inundation frequency
- Design flow shear stress
- Sediment deposition
- Plant community succession





# APPENDIX C

Preliminary Settlement Estimates in Grade Raise Areas  
Prepared by Golder Associates, Ltd.



# **INSERT GOLDER TABLE**